

# EK70 series

All-in-One Energy Storage System

EK70 HS5-(5K-10K)-(S3,S4)-X

---

## User Manual

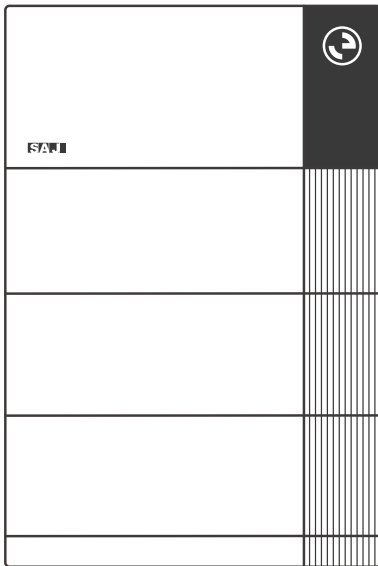

## Copyright Statement

This document, including all text, images, and designs contained herein, is the proprietary information of **Guangzhou Sanjing Electric Co., Ltd.** ("SAJ") and is protected by applicable copyright and trademark laws. No part of this publication may be reproduced, stored, distributed, or transmitted in any form or by any means without the prior written permission of **SAJ**.

The information in this document is provided "as is" for general guidance. While every effort has been made to ensure accuracy and completeness, **SAJ** reserves the right to modify the content herein without prior notice.

Guangzhou Sanjing Electric Co., Ltd. disclaims all implied warranties, including but not limited to warranties of merchantability and fitness for a particular purpose, and shall not be liable for any direct, indirect, incidental, or consequential damages arising out of or in connection with the use of this document or reliance on its content.

**SAJ** (SAJ) used in this document are the trademarks of Guangzhou Sanjing Electric Co., Ltd. All other brand names, trademarks, or registered trademarks mentioned herein are the property of their respective owners.

For the most current version of this document and product support, please scan the QR code or visit our website as shown below:

Website: <https://www.saj-electric.com/>



## Contact us

**Online technical support:** Go to <https://www.saj-electric.com/services-support-technical> to check FAQs or send your message or product enquiry.

**Call for assistance:** For SAJ support telephone numbers, see <https://www.saj-electric.com/locations> for your region support details.

**SAJ head quarter:** Guangzhou Sanjing Electric Co., Ltd.

- . **Address:** SAJ Innovation Park, No.9, Lizhishan Road, Guangzhou Science City, Guangdong, P.R.China.
- . **Tel:** +86 20 6660 8588
- . **E-mail:** [service@saj-electric.com](mailto:service@saj-electric.com)
- . **Website:** <https://www.saj-electric.com/>

**SAJ Australia:** SAJ Digital Energy Australia Pty Ltd

- . **Address:** 11 Banilla Close, POINT COOK, VIC 3030, Australia
- . **Tel:** + 61 1800 888 725
- . **E-mail:** [info@saj-electric.com.au](mailto:info@saj-electric.com.au)
- . **Website:** <https://au.saj-electric.com/>

## **Warranty**

Check the product warranty conditions and terms on the SAJ website: <https://au.saj-electric.com/en-au/services-support-warranty>.

## About this document

This user manual provides product introductions and instructions of operating, maintaining, and troubleshooting the SAJ product.

You can find the latest version of this document as eManual at <https://www.saj-electric.com/>, or scan the QR code below.

Scan for eManuals



### Note:

Illustrations in this document show only essential details and may differ from the actual product.

### Validity

This manual is valid for the following product:

- EK70 HS5-(5K-10K)-(S3,S4)-X

### Target Audience

This document is applicable to the personnel that transport, install, and operate on the product. The personnel are required to have the following qualifications:

- A certain level of expertise in electronics, electrical wiring, and mechanical knowledge in electrical and mechanical schematics.
- Being familiar with the composition and working principles of the product and its upstream and downstream equipment.
- Professional training related to the installation and commissioning of electrical equipment.
- The ability to respond urgently to dangers or emergencies that may arise during installation or commissioning.
- Being familiar with relevant standards and regulations in the country or region where the project is located.
- Being familiar with the contents in this manual.

### Use of the Manual

Read the user manual carefully before any installation, operation and maintenance and follow the instructions during installation and operation. Always keep the printed manual available for future reference.

### Levels of Warning Messages



**DANGER**

Indicates a hazardous situation which, if not avoided, will result in death or serious injury.



**WARNING**

Indicates a hazardous situation which, if not avoided, will result in serious injury or moderate injury.



**CAUTION**

Indicates a hazardous situation which, if not avoided, will result in minor or moderate injury.

 NOTICE

Indicates a situation which, if not avoided, can result in property damage.

## Revision history

Version	Date	Changes
V0	2026-04-28	First version.













# Contents

<b>1. Safety instructions.....</b>	<b>3</b>
1.1. Safety symbols.....	3
1.2. Inverter safety instructions.....	4
1.3. Battery safety instructions.....	6
1.4. Recycling and disposal.....	7
<b>2. Product information.....</b>	<b>8</b>
2.1. Product introduction.....	8
2.1.1. EK70 product models.....	8
2.1.2. Dimension.....	9
2.1.3. Inverter ports and switches.....	10
2.1.4. Blind-mate connectors.....	13
2.1.5. LED on the inverter.....	14
2.2. Grid integration types.....	14
2.2.1. Australia.....	15
2.3. Work mode.....	16
2.4. System overview.....	17
<b>3. Transportation and storage.....</b>	<b>19</b>
3.1. Battery transportation and storage.....	19
3.2. Inverter transportation and storage.....	20
<b>4. Installation instructions.....</b>	<b>21</b>
<b>5. Electrical connection.....</b>	<b>22</b>
5.1. Electrical connection diagram.....	22
5.1.1. Australia and New Zealand.....	22
<b>6. Start up the system.....</b>	<b>24</b>
<b>7. Shut down the system.....</b>	<b>25</b>
<b>8. Commissioning on App.....</b>	<b>26</b>
8.1. About elekeeper.....	26
8.2. Download the elekeeper App.....	26
8.3. Log in to the elekeeper App.....	26
8.4. Perform initialization settings.....	27
8.5. Perform installation diagnosis.....	34
8.6. View or change the inverter settings.....	36
8.7. View the inverter firmware version.....	37
8.8. Configure the communication module.....	37
8.9. Configure the DRM settings.....	38
8.10. Configure the AFCI function.....	39
8.11. View or configure the V-Watt and Volt-Var modes.....	39
8.12. Create a plant.....	42
8.13. View the plant details.....	43
<b>9. System maintenance.....</b>	<b>44</b>
9.1. Routine maintenance.....	44
9.2. Troubleshooting.....	45



# 1. Safety instructions

## 1.1. Safety symbols

Symbol	Description
	<b>Danger:</b> Electrical shock hazard This device is directly connected to public grid and thus all work to the system shall only be carried out by qualified personnel.
	<b>Danger:</b> Hot surface The components inside the battery will release a lot of heat during operation. Do not touch metal plate housing during operating.
	<b>Danger:</b> Risk of electric shock from energy stored in capacitor. Do not open the cabinet door until 5 minutes after disconnecting all sources of supply.
	<b>Warning:</b> No open flames Do not place or install near flammable or explosive materials.
	<b>Caution</b> Keep the product out of reach of children.
	<b>Caution:</b> Check the user manual before service If an error has occurred, refer to the troubleshooting instructions to remedy the error.
	<b>Caution</b> This device shall NOT be disposed of in residential waste.
	<b>Caution</b> This battery module shall NOT be disposed of in residential waste.
	<b>CE Mark</b> Equipment with the CE mark fulfills the requirements of the Low Voltage Directive and Electro Magnetic Compatibility.
	<b>RoHS compliant mark</b> Equipment with the RoHS mark does not exceed the allowable amounts of the restricted substances defined in Restriction of Hazardous Substances in Electrical and Electronic Equipment.
	<b>RCM compliant mark</b> Equipment with the RCM mark is in compliance with AS/NZS 4417.1 & 2 and the EESS.
	<b>Recyclable</b>

## 1.2. Inverter safety instructions

### Personal Safety

#### **DANGER**

##### **Risk of personnel hazard or equipment damage due to improper operations**

Improper operations performed on energized equipment by unqualified personnel may lead to equipment failure or safety hazards.

- Only qualified and trained professionals who are familiar with electrical installation and local codes may install, maintain, or repair the equipment.
- Before any operation, read the safety precautions thoroughly and always follow the standard procedures during operation. Non-standard and improper operations on the energized equipment may cause fire, electric shocks, or explosion.
- Do not reconstruct or alter the equipment, add components, or change the installation sequence without permission. Any unauthorized operation including modification of product functionality of any form may cause lethal hazard to the operator, third parties, the units or their property.
- Before any operation, remove conductive objects such as watches, bracelets, bangles, rings, and necklaces to prevent electric shocks.
- During operation, do not open the housing or touch electrical terminals.

#### **WARNING**

##### **Risk of personal injury due to direct contact with the components or housing**

Direct contact with hazardous moving or hot components during the inverter's operation may lead to personal injury.

- Do not touch a running fan with your hands, components, screws, or any other tools.
- During operation, do not touch heat sink area with bare hands as the inverter surface may become hot.

#### **CAUTION**

##### **Risk of equipment damage and personal injury**

If you detect any unusual odors, hear abnormal noises, or notice smoke during operation, immediately shut down the unit and disconnect all power sources.

#### **NOTICE**

##### **Risk of equipment malfunction and safety hazards**

Failure to follow proper guidance and neglect of regular monitoring prevents the timely identification and prevention of potential issues.

- Read the entire user manual before installation and keep it at hand for future reference.
- Regularly check the status via the monitoring interface to promptly detect any abnormalities.

## Electrical Safety

### DANGER

#### Risk of high voltage and electric shock

Before any operation, disconnect the inverter from all AC and DC power sources and wait at least 5 minutes to allow internal capacitors to discharge.

### WARNING

#### Risk of overheating, fire and equipment damage

Obstructing ventilation or allowing foreign objects to enter the equipment may lead to fire hazards.

- During operation, ensure that the ventilation vents or heat dissipation systems are not obstructed or covered by other objects to prevent fire due to high temperature.
- During operation, prevent foreign matter from entering the equipment. Otherwise, equipment short-circuits or damage, load power derating, power failure, or personal injury may occur.
- Do not place any foreign objects or liquid containers on the inverter.

## Environment Requirements

### DANGER

#### Risk of severe electrical shock

- A lightning strike can induce a sudden and massive power surge, which poses severe hazard to both personnel and equipment.
- Installation, operation, and maintenance is prohibited during thunderstorms.

## Mechanical Safety

### NOTICE

#### Risk of equipment failure or physical injury

Installing or operating an inverter with pre-existing physical damage compromises safety and functionality.

- Before unpacking the inverter, check the outer packing materials for damage, such as holes and cracks, and check the inverter model. If any damage is found or the inverter model is not what you requested, do not unpack the package and contact your supplier as soon as possible.
- Before installation, inspect the equipment for any visible damage or signs of transportation damage. If damage is found, do not install or use the equipment.

### 1.3. Battery safety instructions

 **DANGER**

**Risk of electric shock, short circuit, or equipment damage**

Performing operations on live / defective equipment or improper grounding connection cause electric shock.

- Do not use the battery or the battery control unit if it is defective, broken or damaged.
- Do not subject the battery to any strong force.
- Keep the power off prior to any operations.
- Make sure that the battery is grounded prior to use.
- Do not pull out any cables or open the battery enclosure when the battery is powered on.

 **DANGER**

**Risk of reduced life cycle, fire, or explosion**

Excessive heat or direct exposure to heat sources destabilizes the battery chemistry.

- Do not expose the battery to temperatures more than 50°C.
- Do not place the battery near a heat source, such as direct sunlight, a fireplace.
- Keep inflammable and explosive dangerous items or flames away from the battery.

 **DANGER**

**Risk of short circuit, corrosion, internal damage, or malfunction**

Water, moisture, or specific corrosive gases can damage electronics and battery components.

- Do not soak the battery in water or expose it to moisture or liquids.
- Do not use the battery in areas where the ammonia content of the air exceeds 20 ppm.

 **WARNING**

**Severe injury, death, equipment damage, system failure, and voided warranty**

Improper handling by unqualified individuals can lead to electrical hazards.

- Only qualified personnel with a thorough understanding of local safety regulations and battery standards may install, maintain, remove, or dispose of this product.
- **SAJ Electric** shall not be held liable for any loss or warranty claims resulting from unauthorized product modifications that could lead to fatal injury, harm to third parties, or impaired equipment performance.
- The battery cannot be disposed of as household refuse. When the service life of the battery reaches its limit, it is not required to return it to the dealer or **SAJ**, but it must be recycled to the special waste lithium battery recycling station in the area.

 **WARNING****Risk of fire, explosion, severe burns, equipment destruction**

Short circuit allows high current to flow and generate intense heat.

- To ensure personal and property safety, never short-circuit the positive (+) and negative (-) terminals.
- Connect the batteries in parallel. Do not connect them in series.
- The battery can start only when connected to the inverter. Once disconnected from the inverter, there is no voltage output at the positive and negative terminals. Do not forcibly activate the battery to output voltage by other means.

 **CAUTION****System malfunction, accelerated battery degradation, risk of overheating, and potential safety hazards**

Incompatible components or mixed battery types can lead to improper charging/discharging, voltage imbalance, and communication failures.

- Use this battery only with inverters specified as compatible by the manufacturer.
- Do not mix batteries of different models or specifications in a single energy storage system.

 **NOTICE**

For optimal performance and safety, use batteries from the same production batch to minimize the risk of operational abnormalities.

## 1.4. Recycling and disposal

 **NOTICE**

This product should not be disposed as a residential waste.

Some components inside the equipment can be recycled and reused, while others may pose a pollution risk to the environment. Please contact a locally authorized professional recycling agency for the proper handling of the product and its internal components.

## 2. Product information

### 2.1. Product introduction

#### 2.1.1. EK70 product models

##### Model description

Take EK70-HS5-6K-S3-X-IE as an example.

EK70
HS5
-6K-
S3
-X-
IE

①
②
③
④
⑤

- ① The product series.

---

- ② It means the rated power of the system is 6 kW.

---

- ③ It means single phase with 3 MPPT.

---

- ④ It means the rated capacity in kWh of battery packs.

---

- ⑤ It can be blank or IE. IE means the Ireland model.

---

##### Product models

<b>System</b>	EK70 HS5-5K-S3-X <sup>1</sup>
	EK70 HS5-6K-S3-X
	EK70 HS5-6K-S3-X-IE
	EK70 HS5-8K-S3-X
	EK70 HS5-10K-S4-X
<b>Inverter</b>	EK70 HS5-5K-S3
	EK70 HS5-6K-S3
	EK70 HS5-6K-S3-IE
	EK70 HS5-8K-S3
	EK70 HS5-10K-S4
<b>Battery</b>	EK70 BU5-6.0-TV
	EK70 BU5-7.0-TV
	EK70 BU5-9.0-TV
<b>Battery base</b>	BE5-TV
<b>Wall-mounting bracket</b>	BT5-TV

1. The value of x includes 6, 7, 9, 12, 14, 15, 16, 18, 21, 24, 25, 27, 28, 30, 35, 36, 40, 42, 45, 50, and 54.

## 2.1.2. Dimension

Use one stack with six battery modules as an example:

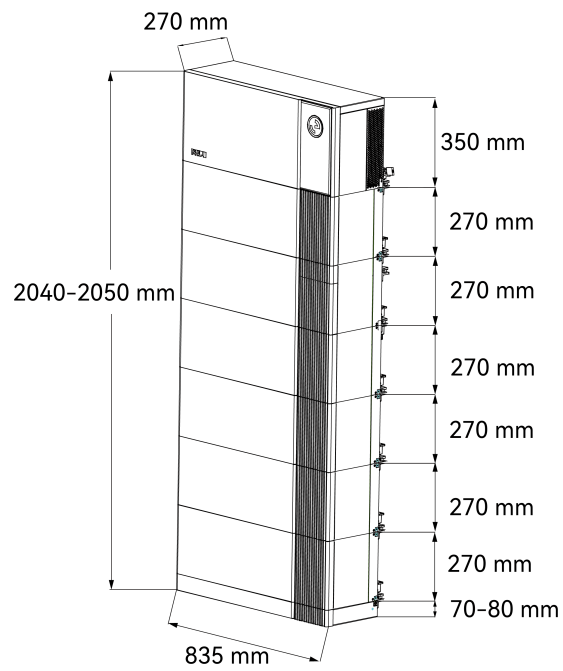
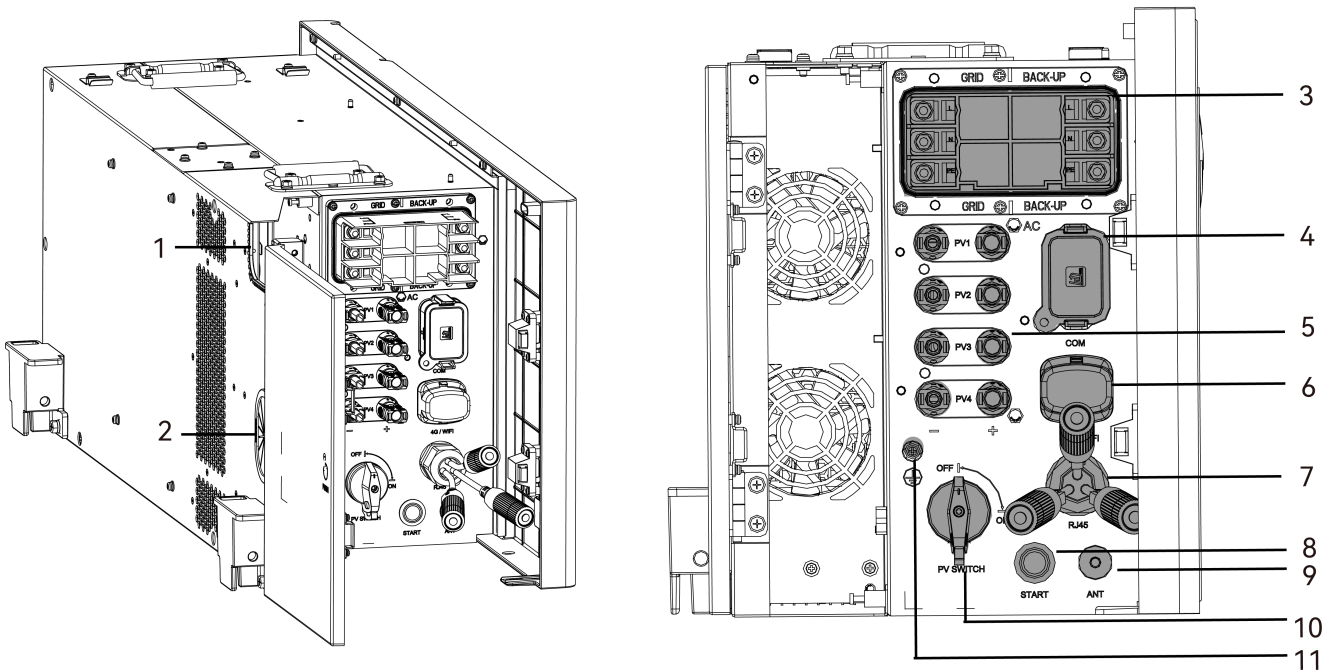

Figure 2.1. Dimensions

### 2.1.3. Inverter ports and switches



Callout	Silkscreen	Description
1	/	The cable entry hole 1 for routing AC power cables.
2	/	The cable entry hole 2 for routing the following cables: <ul style="list-style-type: none"> <li>• The grounding cable</li> <li>• The DC power cables</li> <li>• The communication cables</li> </ul>
3	<b>AC</b> <ul style="list-style-type: none"> <li>• <b>GRID</b></li> <li>• <b>BACK-UP</b></li> </ul>	The connection ports for AC power cables. <ul style="list-style-type: none"> <li>• <b>GRID</b>: for connecting to the public grid.</li> <li>• <b>BACK-UP</b>: for connecting to the home backup load.</li> </ul>
4	<b>COM</b>	The connection port for communication cables from external devices like DI/DO devices.
5	<b>PV1, PV2, PV3, PV4</b>	The negative and positive PV input connection ports.
6	<b>4G/WIFI</b>	The connection port of the eSolar AIO3 Pro and 4G Pro communication modules.
7	<b>RJ45</b>	The RJ45 connection ports for LAN1, LAN2, and DRMS connections. LAN1 and LAN2 are reserved for future use.
8	<b>START</b>	For starting up the energy storage system.
9	<b>ANT</b>	The LoRa antenna connection port.
10	<b>DC SWITCH</b>	The DC switch that controls the connection to the PV array.

Callout	Silkscreen	Description
11		The grounding cable connection port.

Table 2.1. Inverter electrical ports



Number	Silkscreen	Description
1-6	/	Reserved for future use.
7	<b>DO1+</b>	Output connection for dry contact device 1.
8	<b>DO1-</b>	Output connection for dry contact device 1.
9	<b>DO2+</b>	Output connection for dry contact device 2.
10	<b>DO2-</b>	Output connection for dry contact device 2.
11	<b>PC 485A</b>	Reserved RS485 connection ports.
12	<b>PC 485B</b>	The RS485 communication can be adjusted with the provided 120 Ω resistor controlled by <b>SW2</b> DIP switch.
13	<b>Meter 485A</b>	For RS485 connections with the meter.
14	<b>Meter 485B</b>	The RS485 communication can be adjusted with the provided 120 Ω resistor controlled by <b>SW3</b> DIP switch.
15	<b>DI1+</b>	Input connection for dry contact device 1.
16	<b>DI1-</b>	Input connection for dry contact device 1.
17	<b>DI2+</b>	Input connection for dry contact device 2.
18	<b>DI2-</b>	Input connection for dry contact device 2.
19	<b>12V</b>	Port for providing 12V DC power supply to the external device.
20	<b>GND</b>	Port for grounding connection.

Table 2.2. 20-pin definition for COM port

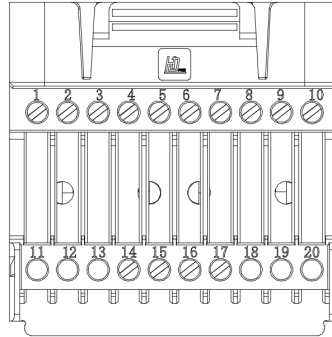
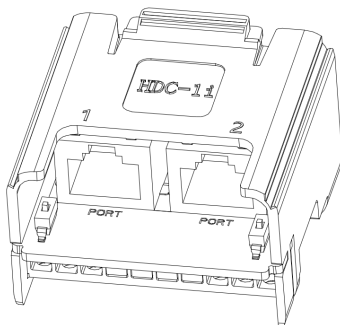
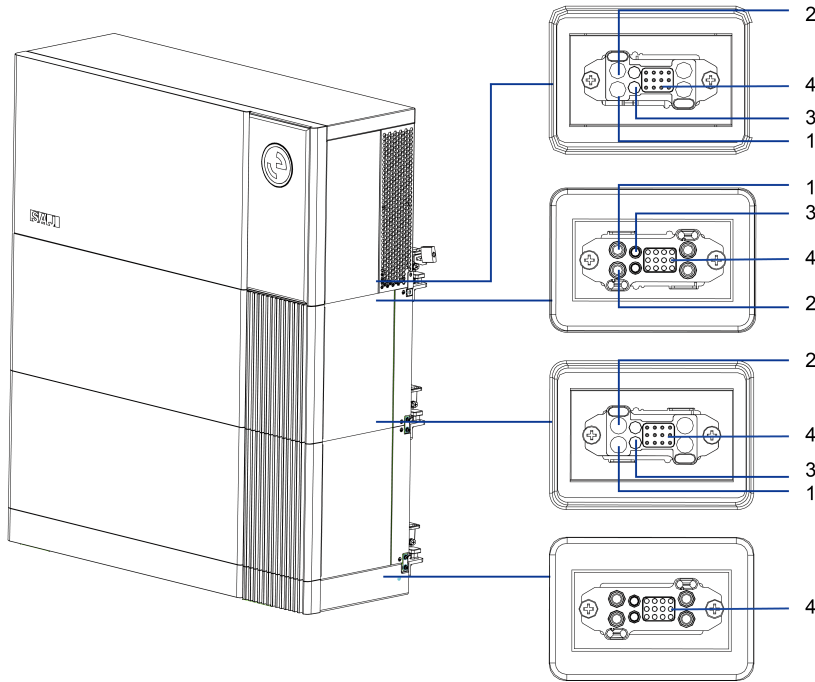

Figure 2.2. RJ45 ports for communication connector

Number	Silkscreen	Description
1	<b>PORT CAN</b>	Reserved for future use.
2	<b>DSP CAN</b>	Reserved for future use.

### 2.1.4. Blind-mate connectors

The EK70 system is equipped with blind-mate connectors on the inverter, batteries, and battery base, ensuring quick electrical connection and communication among these components. The following figure shows the positions and ports of the connectors.



Number	Designation
1	The positive pole port of the blind-mate connector.
2	The negative pole port of the blind-mate connector.
3	The protective earth (PE) port of the blind-mate connector.
4	The communication ports of the blind-mate connector.
Non-labeled ports	Reserved for future use.

### 2.1.5. LED on the inverter



Figure 2.3. Inverter LED panel

Display	Color	Status	Description
	Green	Solid on	The inverter is working properly with grid connection.
		Breath, on 1.5s, off 1.5s	The inverter is in initialization or standby state.
		Breath, on 3s, off 3s	The inverter is working properly off-grid.
		Breath, on 0.5s, off 0.5s	The inverter is working off-grid with SOC lower than 20%.
	Red	Solid on	The inverter is faulty.
	Yellow	Breath, on 3.5s, off 3.5s	The inverter is upgrading.
Gray	Off	The inverter is powered off.	

Table 2.3. LED light

Display	Color	Status	Description
	White	Integer (example, 50)	Battery state of charge (SOC). For example, 50%.
		--	The battery communication is lost.
	White	Solid on	The PV array is working.
		Off	The PV array is not connected.
	Red	Solid on	The PV array is faulty.
	White	Solid on	The battery is charging.
		Breath, on 1s, off 1s	The battery is discharging.
		Off	The battery is disconnected or inactive.
	Red	Solid on	The battery is faulty.
	White	Solid on	The inverter is working with grid connection.
		Breath, on 3s, off 3s	The inverter is working off-grid.
		Off	No grid is detected.
	Red	Solid on	AC connection point is faulty.
	White	Solid on	In good communication with the meter, BMS, and cloud.
		Breath, on 1s, off 1s	Lost communication with the meter, BMS, or cloud.
	Red	Off	Lost communication with all the meter, the BMS, and cloud.

Table 2.4. LED indicators

## 2.2. Grid integration types

## 2.2.1. Australia

### Multi-phase combinations

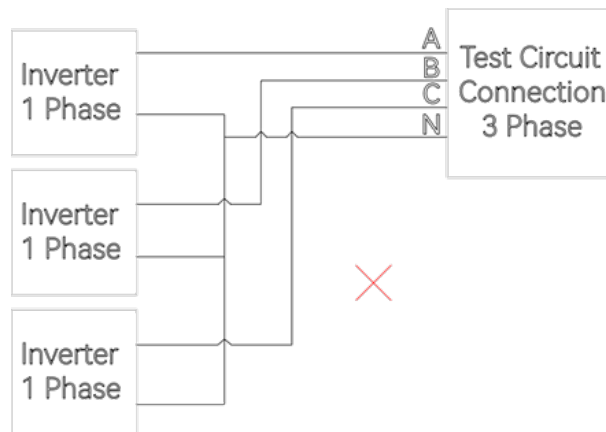

The inverter should not be installed in multiple phase combinations. If any such multiple inverter combination is not tested, it should not be used, or external devices should be used in accordance with the requirements of AS/NZS 4777.1.

## 2.3. Work mode

The EK70 system supports the following working modes:

### AI Mode

The working mode with AI Saving enabled. The system leverages AI-powered intelligent scheduling based on forecasts of PV generation, load demand, and electricity pricing to optimally allocate energy sources and usage, minimizing electricity bills and maximizing grid-export revenue.

### Self-consumption Mode

The self-consumption mode maximizes the use of electricity generated by PV and minimizes the electricity purchased from the grid to reduce costs.

Period	Working logic
PV power is sufficient	<b>[PV → Loads &gt; Battery &gt; Grid]</b> Any PV power will first supply the loads, with any surplus being used to charge the battery. Any excess power can then be exported to the grid.
PV power is insufficient	<b>[Battery + Grid → Loads]</b> Both the battery and the grid power the loads. The battery discharges power to the loads first. Once the battery reaches its minimum SOC, it stops discharging, and the grid supplies power to the loads.

### Time-of-use Mode

The time-of-use mode allows the users to set the battery charging and discharging time according to the local peak and valley electricity prices.

Period	Working logic
Charging period (with lower electricity price)	<b>[Grid → Battery]</b> The battery charges from the grid at a preset charging power until reaching the preset stop-charging SOC (%).
Discharging period (with higher electricity price)	<b>[Battery → Loads]</b> The battery discharges to loads at a preset discharging power until reaching the preset stop-discharging SOC (%).
Other period	The working logic is the same as self-consumption mode.

## 2.4. System overview

This section shows the typical integration solutions of EK70 system.

### Whole home backup solution

In the whole home backup solution, the EK70 system supports to integrate with a manual transfer switch that allows the whole home load to connect to and switch between the inverter AC backup output and the public grid. If the grid goes off, the whole home load can be manually switched to the EK70 system immediately, and vice versa.

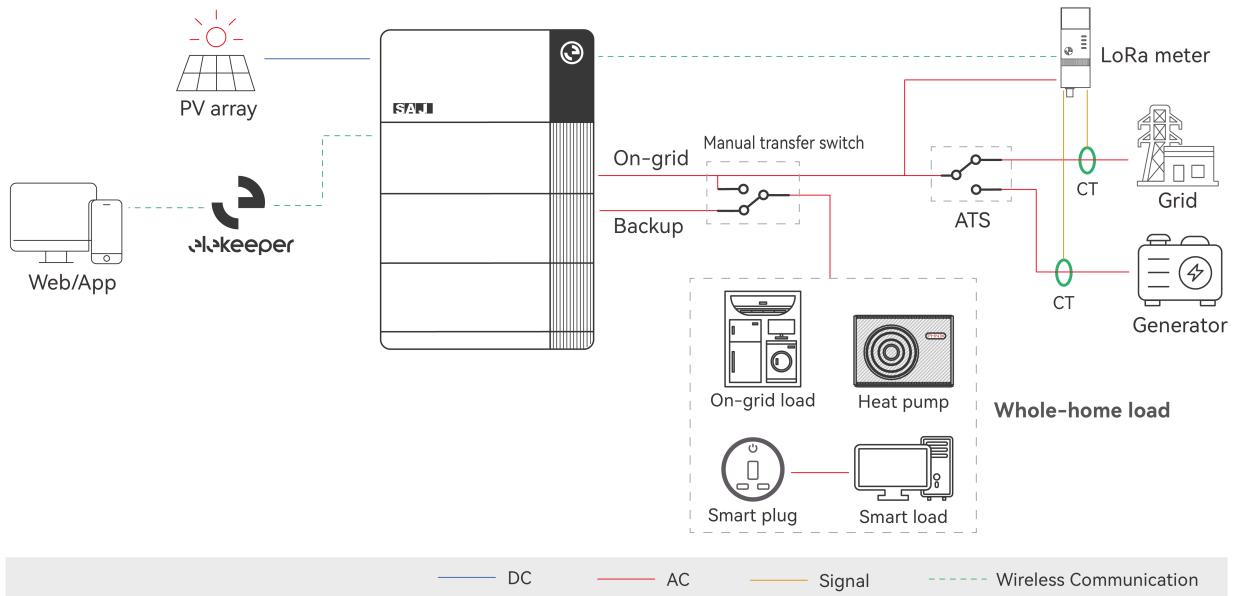

Figure 2.4. Whole home backup solution

Brand	Specification
Lazzen	<ul style="list-style-type: none"> <li>• Single-phase: NDQ2S-63/1P</li> <li>• Three-phase: NDQ2S-63/3P</li> </ul>

Table 2.5. Manual transfer switch specification

### Partial backup solution

In the partial backup solution, the on-grid load can be connected to the grid AC output of the EK70 system, and the off-grid load can be connected to the AC backup output of the system.

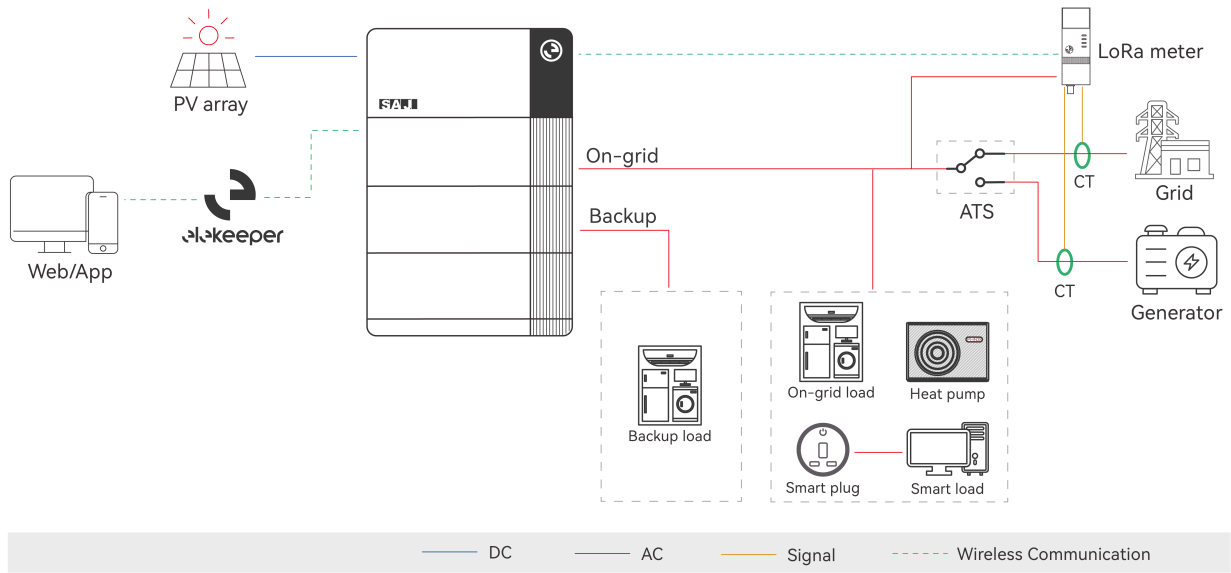

Figure 2.5. Partial Backup Solution

In both solutions, the EK70 system provides a dual-channel wireless meter. The meter supports wireless communication with the system at an optimal distance of 150 meters when penetrating walls.

The EK70 system also supports to integrate with wired meter connections through RS485 communication.

### 3. Transportation and storage

#### 3.1. Battery transportation and storage

##### Transportation

#### WARNING

- The product has passed the UN38.3 test and meets the transportation requirements for dangerous goods, including lithium-ion batteries.
- The transportation service provider must be qualified to transport dangerous goods.
- Before transportation, check that the battery package is intact and that there are no abnormal odour, leakage, smoke or signs of burning. Otherwise, the batteries must not be transported.
- Keep no more than **6** cartons of batteries in one stack.
- Load or unload batteries with caution. Otherwise, the batteries may short circuit or become damaged like leakage or cracking, catch fire or explode.

#### NOTICE

After installing the battery on site, keep the original packaging containing the lithium-ion battery identification. When the battery needs to be returned to the factory for repair, use the original packaging to transport it.

##### Storage

#### NOTICE

- The battery remains 50% power when it is sent from the factory.
- The longer the battery is stored, the lower the SOC. If the battery remaining voltage fails to reach the startup voltage requirement, the battery may be damaged.

The battery should be installed within 6 months since delivered from the factory and used with compatible inverters.

Environment requirements for storage within one month:

- Temperature range: -20 °C to +45 °C
- Relative humidity: 5% to 95% RH

Environment requirements for storage within one year:

- Temperature range: 0°C to 35 °C
- Relative humidity: < 85% RH

### 3.2. Inverter transportation and storage

#### DANGER

- Observe all safety symbols displayed on the packaging prior to transportation.
- Maintain stable driving conditions throughout transportation to prevent the inverter from colliding or dropping, as internal power components may be damaged, potentially causing short circuits or explosions upon subsequent power-up.
- Ensure that transport vehicles are not overloaded and that weight is distributed evenly.
- Do not drill holes into the product or its housing for any transportation-related purpose. Such modifications can damage the structural integrity and functionality of the device.
- Do not store or transport the equipment in damp, flammable, or explosive environments.

#### WARNING

- When moving the equipment, use the original packaging or dedicated handling tools to avoid muscle strain from lifting heavy objects alone.
- Wear suitable protective gloves when manually handling equipment.
- When lifting the inverter, grip it firmly at the designated handles and support the base. Keep the unit level to avoid dropping.
- Do not unpack the inverter packaging if it is not used immediately.
- Do not store the inverter in areas exposed to direct sunlight, rain, strong electric fields, or high humidity. Such conditions can cause overheating, electrical failure, or corrosion.
- Do not store inverters near chemically corrosive substances or in locations prone to pests or rodents. These can cause irreversible damage to housing and internal components.
- Do not stack heavy objects on top of the inverter enclosure during storage.
- Do not tilt or invert the packaging. Maintain the upright orientation as indicated on the carton to prevent internal displacement or component stress.

#### CAUTION

- Store inverters in a clean, dry, and well-ventilated area to avoid moisture buildup and overheating.
- Promptly replace any packaging materials that have been damaged by insects or rodents.

#### NOTICE

- It is recommended to retain the original packaging for future relocation or return for repair.
- Before long-term storage (exceeding 6 months), ensure the storage environment meets requirements and periodically inspect the packaging integrity. Check for environmental damage, pest intrusion, or packaging degradation.

Storage environment requirements:

- Temperature range: -40 °C to +60 °C
- Relative humidity: 5% to 95% RH
- Corrosion protection level: C4

## **4. Installation instructions**

For detailed installation instructions, see the *Quick Installation Guide* of this product.

## 5. Electrical connection

### 5.1. Electrical connection diagram

#### 5.1.1. Australia and New Zealand

This section shows the system connection diagrams applicable to Australia and New Zealand.

- To comply with AS/NZS3000, the neutral (N) cables of the grid and backup-load sides (where applicable) must be connected together.
- Do not connect the PE terminal of the **BACKUP** port.
- The E-BAR and the N-BAR must be connected as illustrated.

#### Whole home backup solution

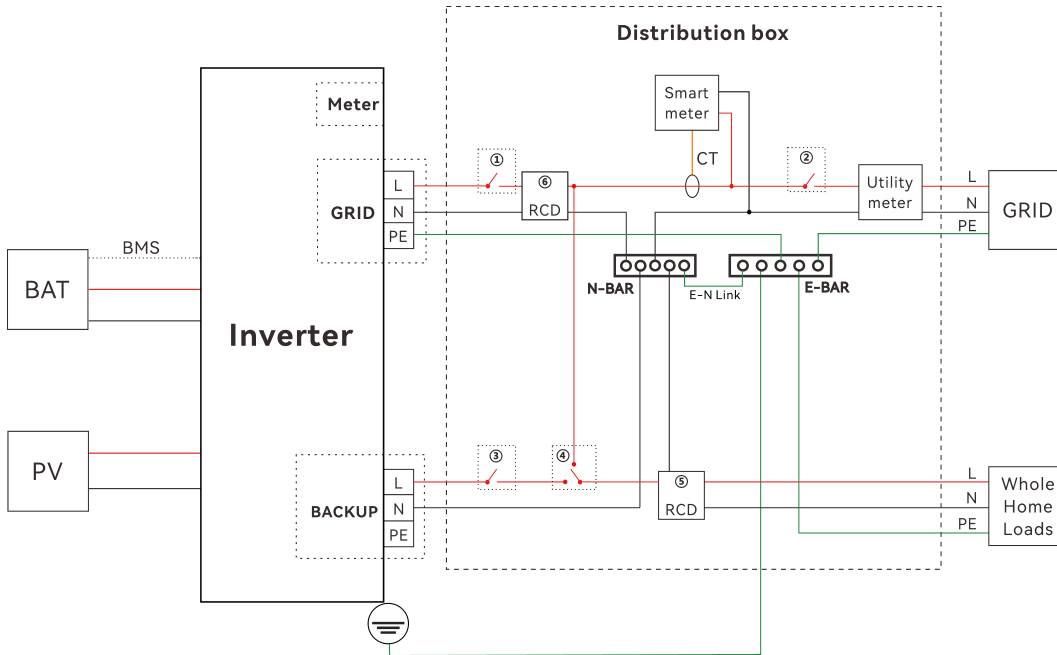

Product model	① AC breaker (grid)	③ AC breaker (backup loads)	② AC breaker (utility meter)	④ Manual transfer switch	⑤⑥ RCD (on-grid/backup loads) <sup>1</sup>
EK70 HS5-5K-S3-X	63 A/230 V	63 A/230 V	Main breaker	63 A/230 V	30 mA
EK70 HS5-6K-S3-X (-IE)	63 A/230 V	63 A/230 V	Main breaker	63 A/230 V	30 mA
EK70 HS5-8K-S3-X	63 A/230 V	63 A/230 V	Main breaker	63 A/230 V	30 mA
EK70 HS5-10K-S4-X	63 A/230 V	63 A/230 V	Main breaker	63 A/230 V	30 mA

Table 5.1. Recommended AC breaker and RCD specifications

1. The on-grid RCD is optional since the inverter is integrated with a residential current monitoring unit (RCMU). However, if the external RCD must be installed according to the local regulations, install a type A RCD of action current 30 mA or higher.

**Note:** The values in the above table are recommendations only and can be set to other values based on the actual conditions.

Partial backup solution

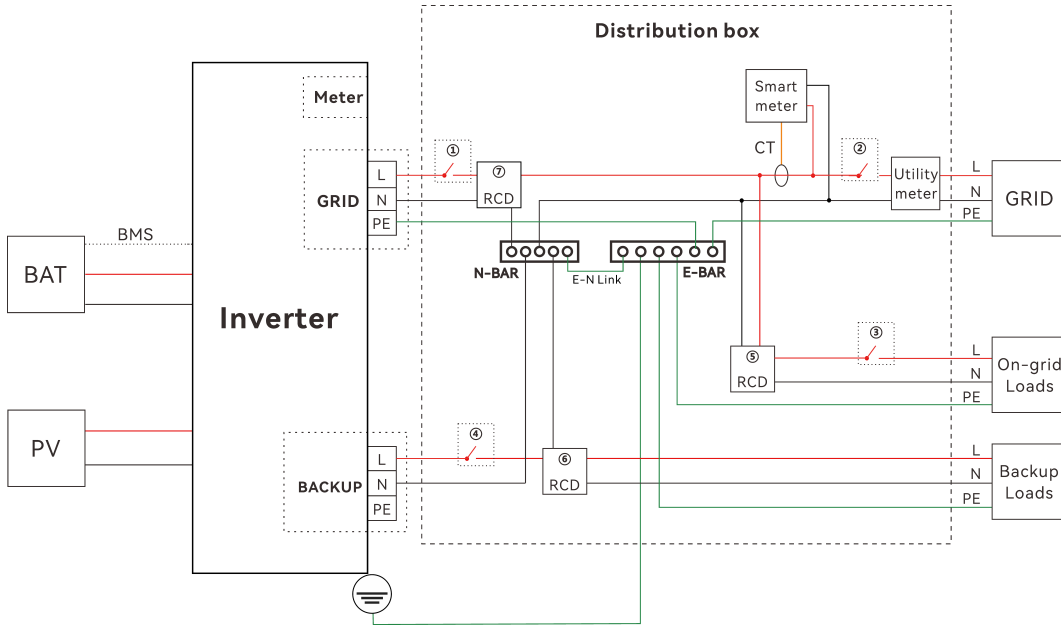

Product model	① AC breaker (grid)	④ AC breaker (backup loads)	② AC breaker (utility meter)	③ AC breaker (on-grid loads)	⑤⑥ RCD (on-grid/backup loads) <sup>1</sup>
EK70 HS5-5K-S3-X	32 A/230 V	Depend on loads	Main breaker	Depend on loads	30 mA
EK70 HS5-6K-S3-X (-IE)	40 A/230 V	Depend on loads	Main breaker	Depend on loads	30 mA
EK70 HS5-8K-S3-X	50 A/230 V	Depend on loads	Main breaker	Depend on loads	30 mA
EK70 HS5-10K-S4-X	63 A/230 V	Depend on loads	Main breaker	Depend on loads	30 mA

Table 5.2. Recommended AC breaker and RCD specifications

1. The on-grid RCD is optional since the inverter is integrated with a residential current monitoring unit (RCMU). However, if the external RCD must be installed according to the local regulations, install a type A RCD of action current 30 mA or higher.

**Note:** The values in the above table are recommendations only and can be set to other values based on the actual conditions.

## 6. Start up the system

### Before you begin

Verify that all the electrical connections are properly wired and secured before starting up the system.

1. Open the AC distribution box.
2. Turn on the following circuit breakers in sequence.
  - a. The backup loads
  - b. The grid
3. On the left side of the inverter, perform the following steps:
  - a. Turn on the DC switch to enable the connection to the PV arrays.
  - b. Press and hold the **START** button for five seconds until the LED indicator on the front panel is on.
  - c. Check the LED indicator status on the inverter panel to ensure that the inverter is running properly.

## 7. Shut down the system

1. Open the AC distribution box.
2. Turn off the following circuit breakers:
  - a. The backup loads
  - b. The grid
3. On the left side of the inverter, perform the following steps:
  - a. Turn off the DC switch to disconnect from the PV arrays.
  - b. Press and hold the **START** button for five seconds, and then release the button and wait until the LED indicator on the front panel is off.

Once the system is shut down, there is no voltage output at the positive and negative terminals. Do not forcibly activate the system to output voltage by other means.

## 8. Commissioning on App

### 8.1. About elekeeper

The elekeeper is an easy-to-use, AI-powered energy management platform designed for homeowners and businesses. It gives the Owner full control over their energy – from generation and storage to consumption and selling – through a single App that works on phones, tablets, and computers.

**Key features:**

- Real-time, centralized monitoring: The Owner can view the status and performance of all energy devices anytime, anywhere.
- AI-powered scheduling: The system automatically optimizes when to store, use, or sell energy to maximize efficiency and savings.
- Smart diagnostics: The platform detects potential issues early and sends alerts to the Owner before problems occur.
- Actionable insights: Clear, data-driven reports help the Owner make smarter decisions and potentially increase revenue from their energy system.

### 8.2. Download the elekeeper App

Search for "elekeeper" in the App store and download the App.

Alternatively, scan the below QR code to download the App.



**Note:** The detailed operations on the App might vary, depending on the App version in use.

### 8.3. Log in to the elekeeper App

1. Open the App and tap the three-dot icon ... on the top right corner.
2. Set **Language** to English and **Network Node** to European Node or International Node depending on the installation site of the system.

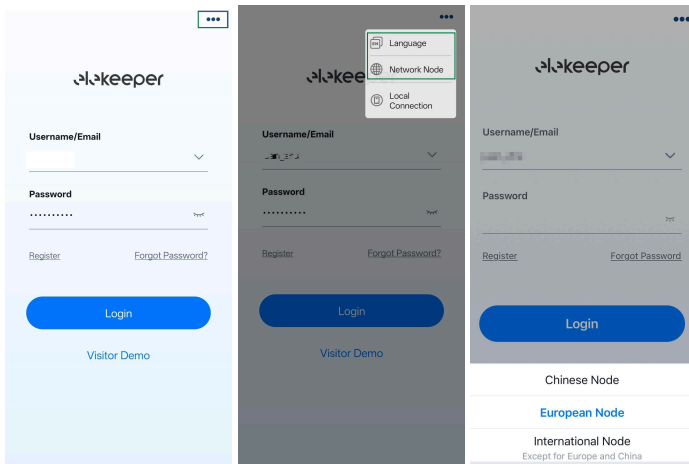

3. If you do not have an account, register first.

- a. Tap **Register**. Choose whether you are an owner, installer, or distributor.
- b. Follow the instructions on the screen to complete the registration.

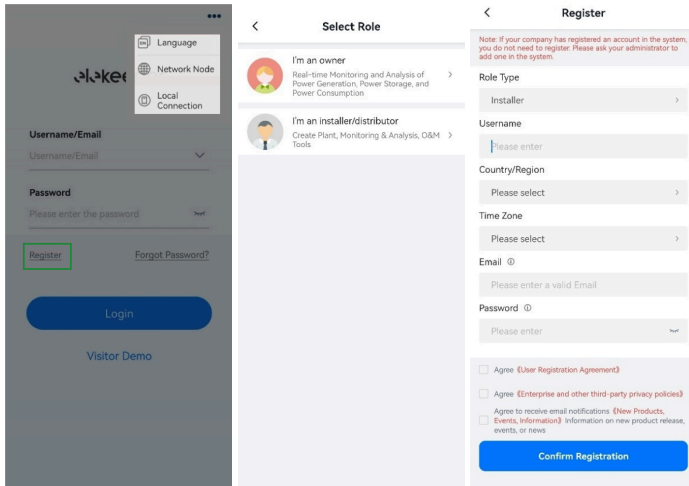

4. Use the account and password to log in to the App.
5. On the **Service** page, select Remote Configuration.
6. Check that Bluetooth is enabled on your mobile phone. Tap **Bluetooth** and then select the communication module or EMS to be connected.

The **BlueLink** is named with the last five numbers of the machine's SN. For example, 42665.

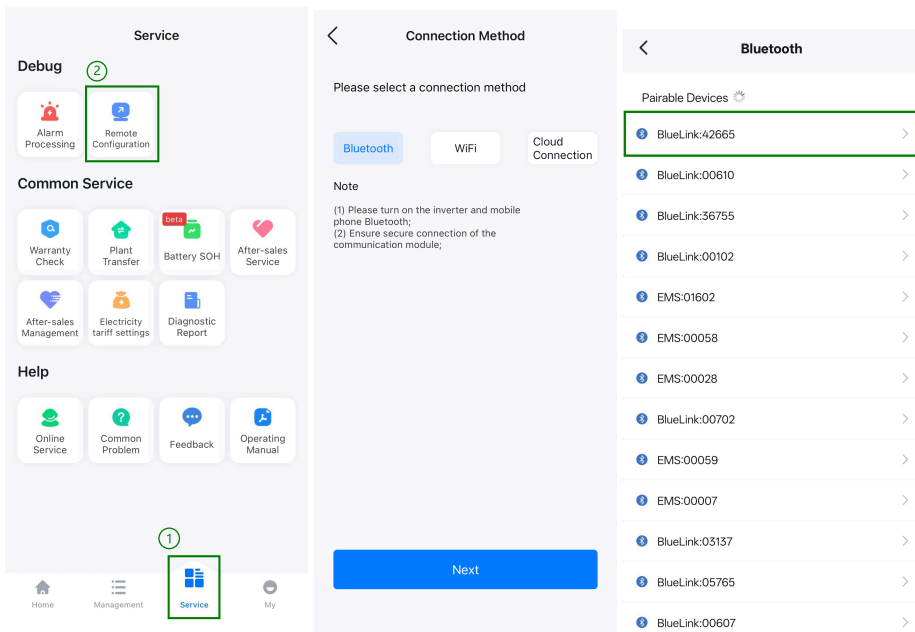

## 8.4. Perform initialization settings

### Country and grid compliance settings

1. On the **Local Connection** page, tap **Grid Code Settings**.
  - a. **Country**: the equipment installation location.
  - b. **Grid Compliance**: the grid setting.

For Australia, select the specific type of compliance according to the owner's grid configuration.

- **AS4777\_AustraliaA:** For large interconnected power system.
  - **AS4777\_AustraliaB:** For small interconnected power systems. For example, Western Power.
  - **AS4777\_AustraliaC:** For isolated or remote power systems. For example, Horizon Power and TasNetworks.
- c. **Inverter Time:** Tap **AUTO TIME SYNC** to synchronize with the time of the device where the App is installed.

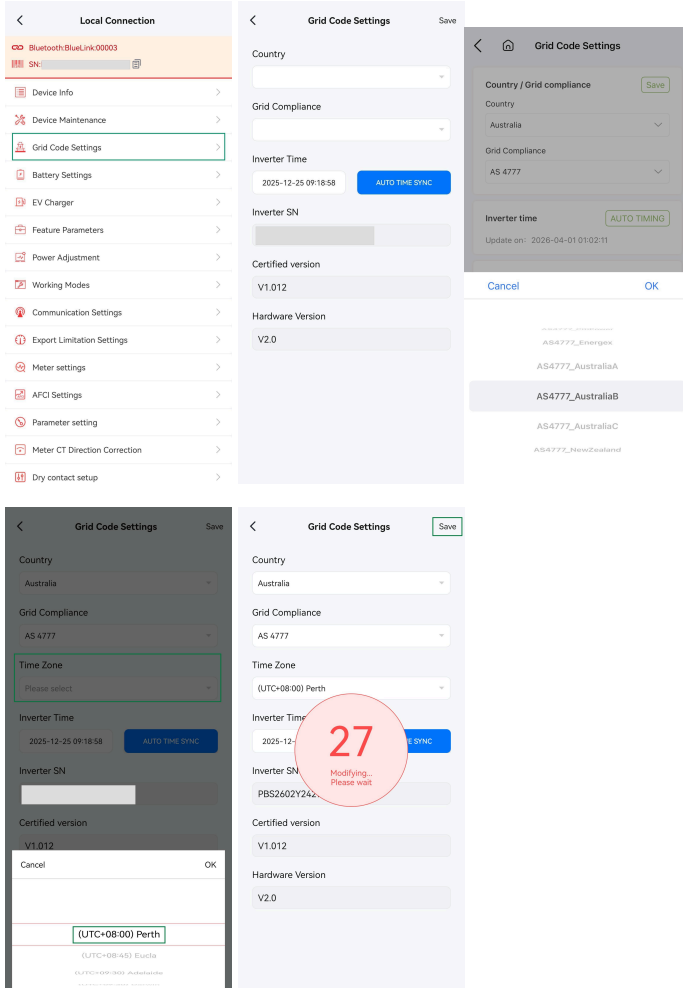

## Battery settings

2. On the **Local Connection** page, tap **Battery Settings**.

a. Select the battery brand:

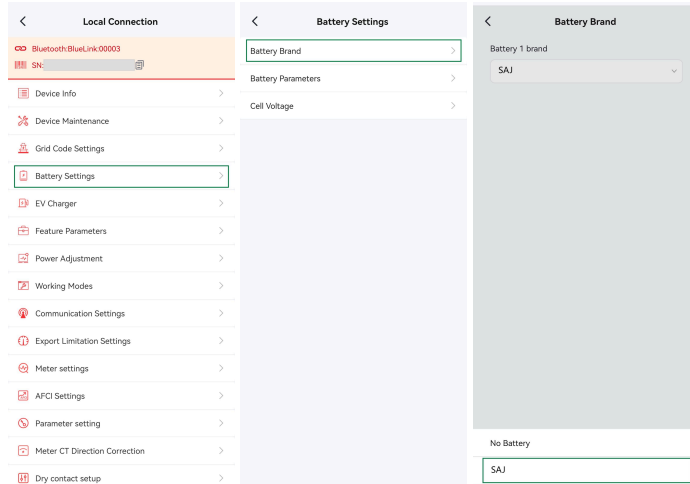

b. Tap **Battery Parameters > Battery Pack 1** to set **Battery discharge capacity lower limit** and **Battery SOC**.

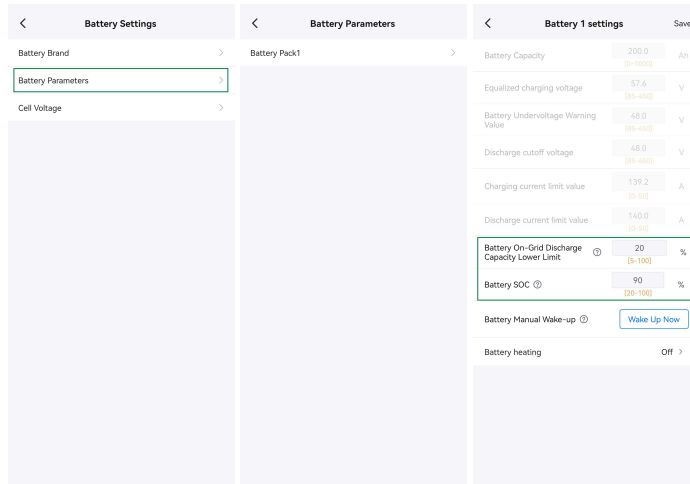

c. (Optional) Set **Battery Heating Time**.

**Note:** This function is only available for EK90 series.

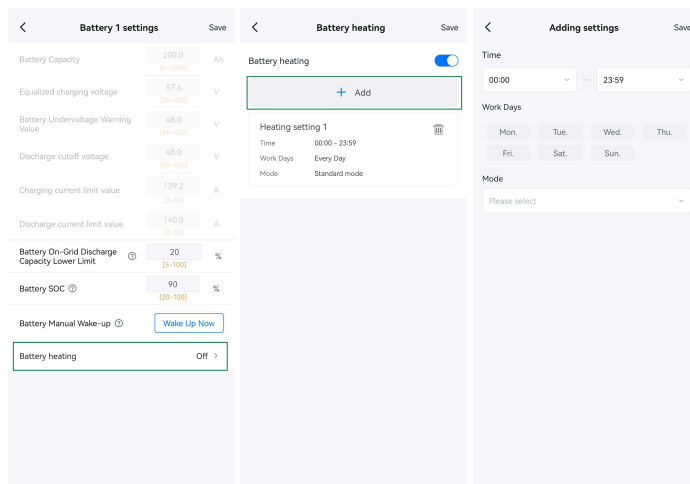

- d. (Optional) Tap **Wake Up Now** to wake up the battery manually when the battery enters a protective hibernation state due to over-discharge.

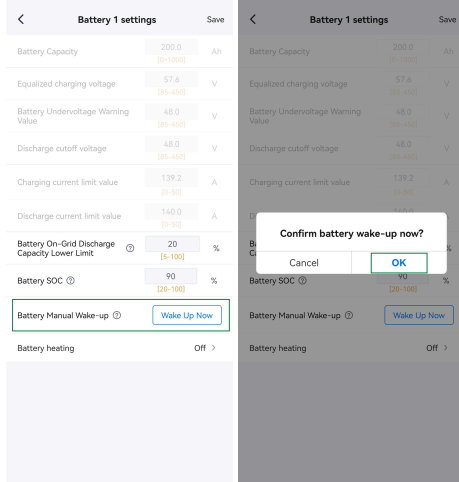

- e. Tap **Cell Voltage > Battery Pack > Battery Cluster** to set each cell voltage.

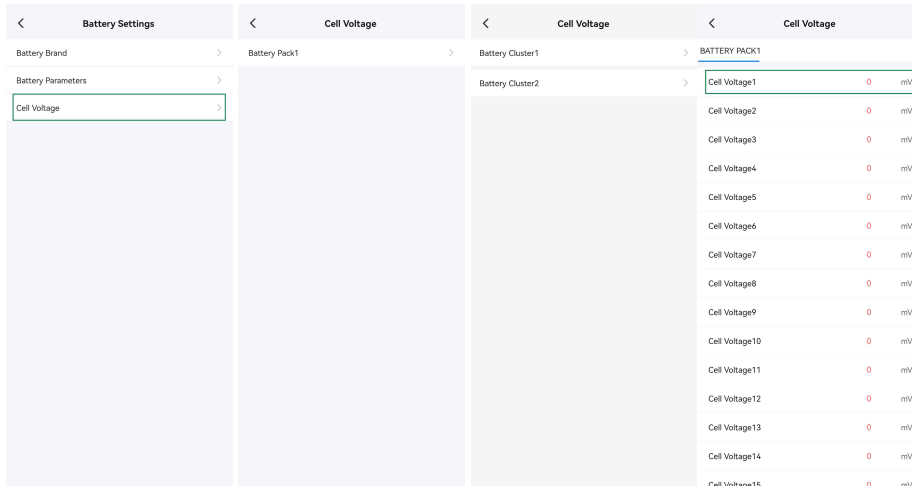

### Meter settings and system schematic

3. Tap **Meter Settings**. Select **Wiring Method** and **Grid Type** based on the actual system configuration.

The image displays four sequential screenshots of the 'Meter settings' configuration interface. The first screenshot shows the 'Local Connection' menu with 'Meter settings' highlighted. The subsequent three screenshots show the 'Meter settings' screen with different configurations:

- Screenshot 2:** 'Wiring Method' is set to 'No Meter' and 'System Schematic' is 'No Meter' (checked).
- Screenshot 3:** 'Wiring Method' is set to 'One Single-Phase Meter' and 'Grid Type' is 'Please select'.
- Screenshot 4:** 'Wiring Method' is set to 'One Single-Phase Meter' and 'Grid Type' is 'L/N'. A 'System Schematic' diagram is shown below, illustrating a single-phase meter connected to a D/C source and an A/C load.

### Working mode settings

4. Tap **Working Modes > Current mode** and select the desired working mode.

Check the pop-up window information to ensure full understanding of the chosen working mode.

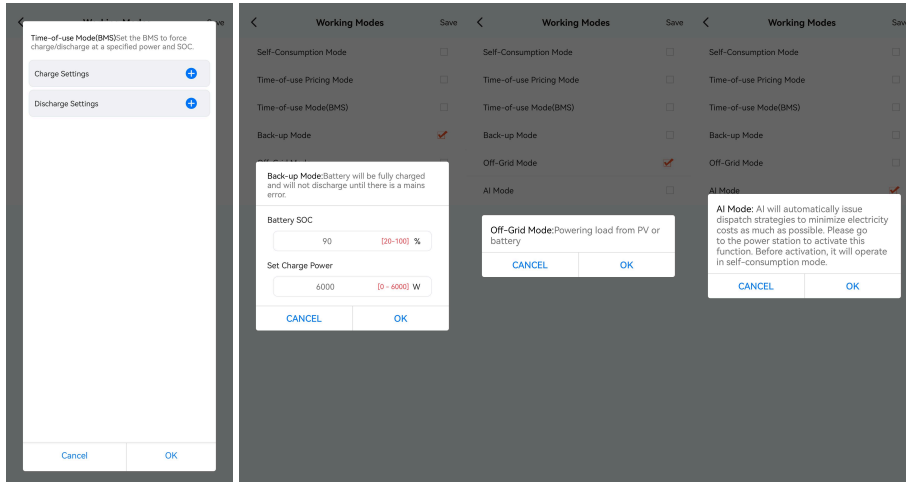
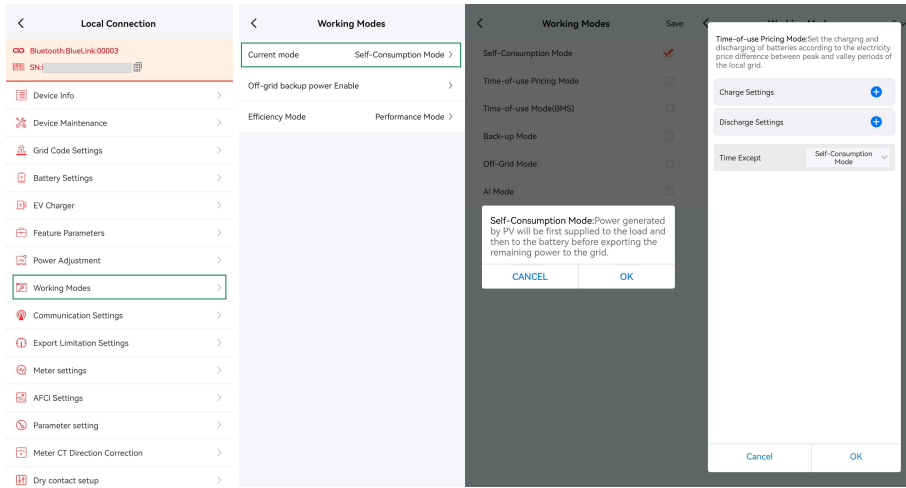

a. (Optional) Tap the **off-grid backup power enable** switch if off-grid mode is selected.

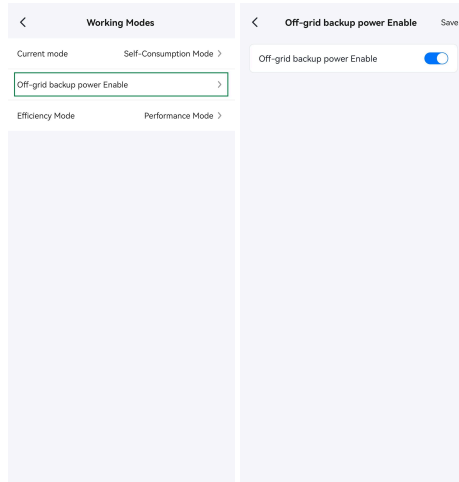

b. Tap **Efficiency Mode** and select **Performance mode** or **Power saving mode**.

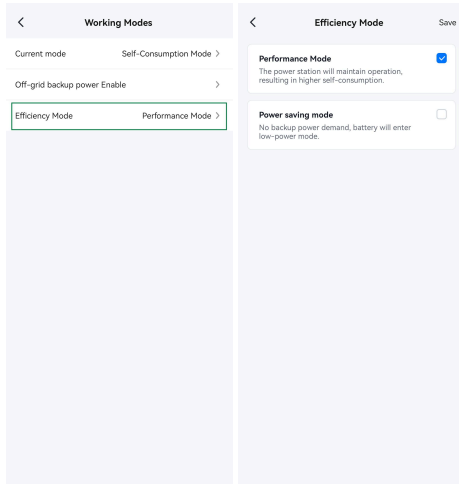

**Export limitation settings**

5. On the **Local Connection** page, tap **Export Limitation Settings**.

- **soft export limit:** enable software limit control only, and the export limit is the user-defined power limit value.
  - In case of communication loss, the inverter exports power within the AC grid output power limit.
  - In 60 seconds after communication recovery, the export limit is controlled by the user-defined power limit value again.
- **hard export limit:** enable both software and hardware limit controls.
  - When the export power exceeds the user-defined limit for 5 seconds, the inverter enters standby mode. The inverter restarts automatically in 60 seconds, gradually ramping up its output power.
  - In case of communication loss for 5 seconds, the inverter stops working.
- **hard/soft generation limit:** the control mode is similar to **hard export limit**. Only that the inverter enters standby mode when the export power exceeds the user-defined limit for 15–20 seconds.
- **Time-of-use export limitation settings:** For time-of-use working mode, configure the date and time for the limit control to take effect.

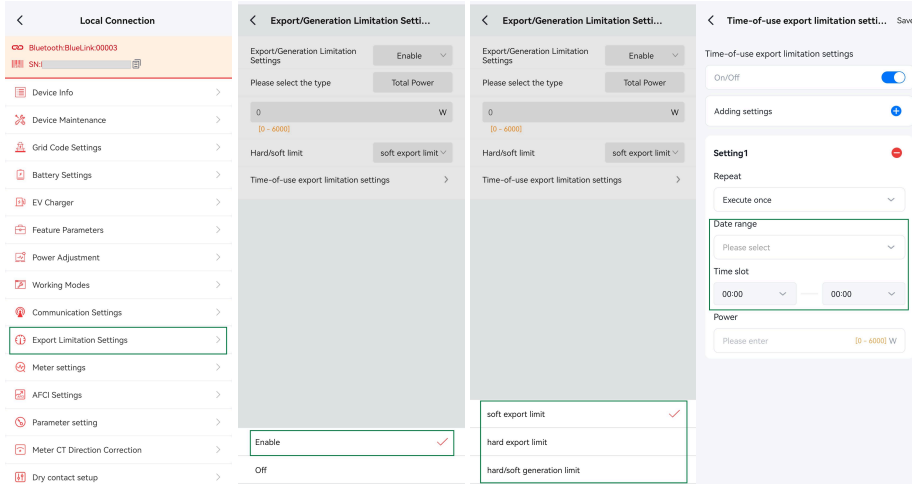

**8.5. Perform installation diagnosis**

After the inverter initialization is completed, perform one-click installation diagnosis to verify the installation status of the system, including the network connection, battery settings, wiring status, and so on.

1. Log in to the elekeeper App and connect to the inverter through Bluetooth connection.
2. On the **Device List** page, tap **Installation diagnosis**.
3. On the **Installation diagnosis** page, tap **One-click diagnosis** to start the diagnosis.  
If the software versions of the inverter are too low, follow the prompt-up to upgrade the system version first.
4. After the diagnosis is completed, check the abnormalities in the report. Handle the issue according to the diagnosis result and the suggested solution.  
If necessary to change the parameter settings, select item on the diagnosis result page.

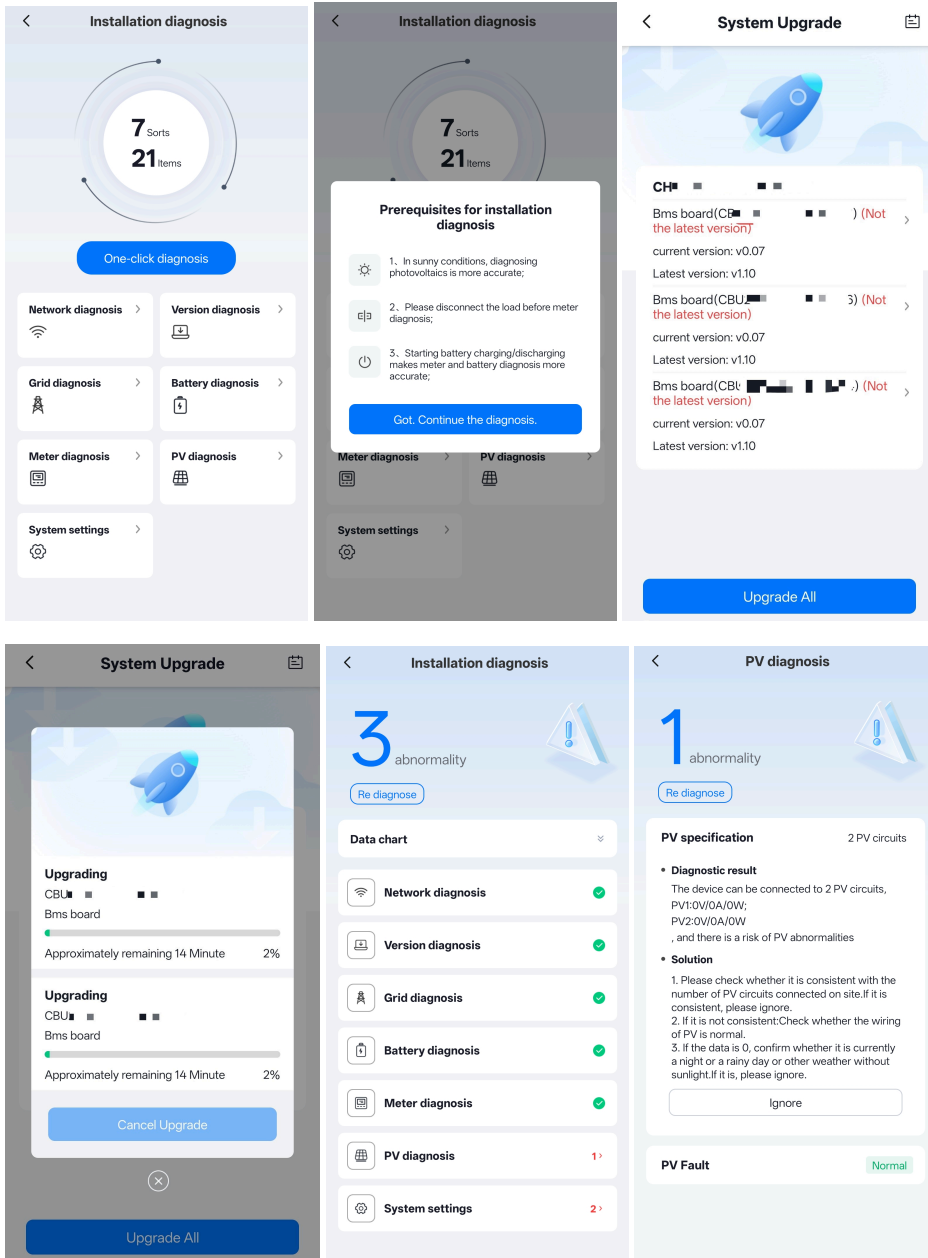

## 8.6. View or change the inverter settings

1. (Installer only) To view the country and grid compliance, perform as follows:

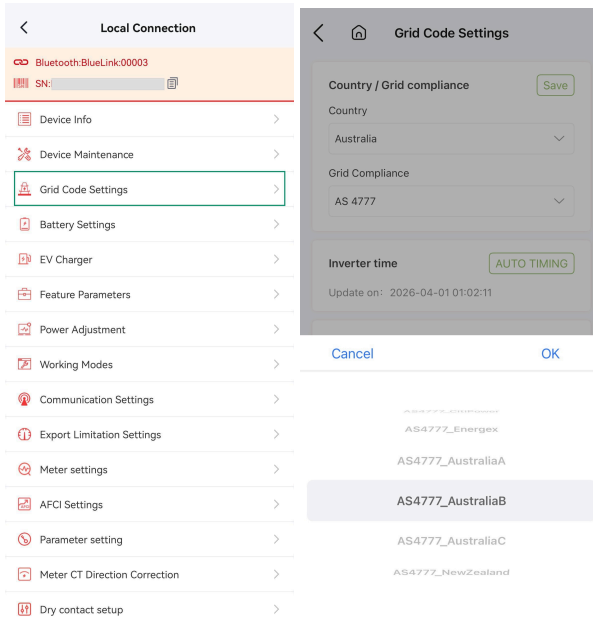

2. (Installer only) To view the protection parameters, perform as follows:

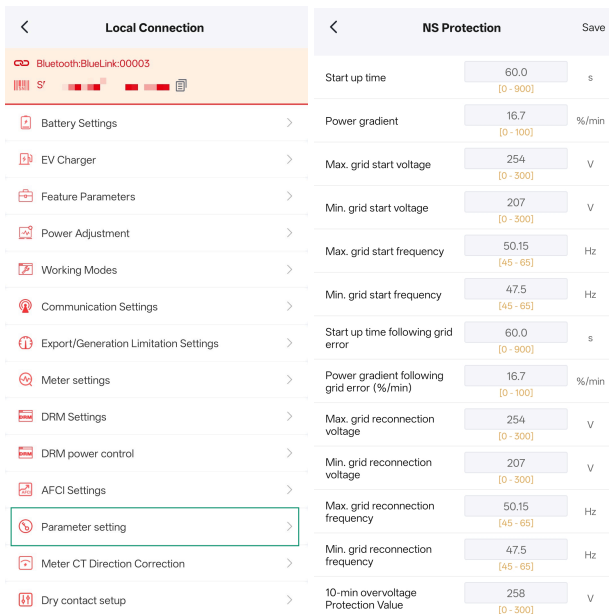

**Note:** Consult SAJ technical support before changing the protection parameters.

3. (Installer only) To view or change the export limit function, perform as follows:

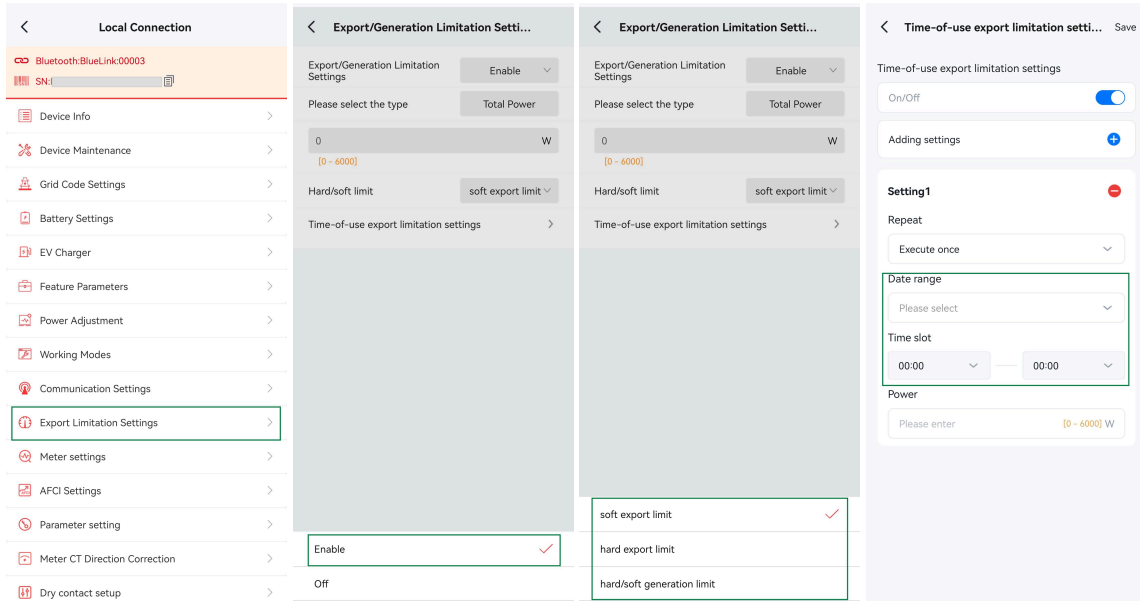

## 8.7. View the inverter firmware version

(Installer only) View the following inverter firmware version on page **Local Connection > Device Info > Basic Info**:

- – **Display Board Version:** advanced RISC machine (ARM) version
- **Control Board Version:** digital signal processor (DSP) version

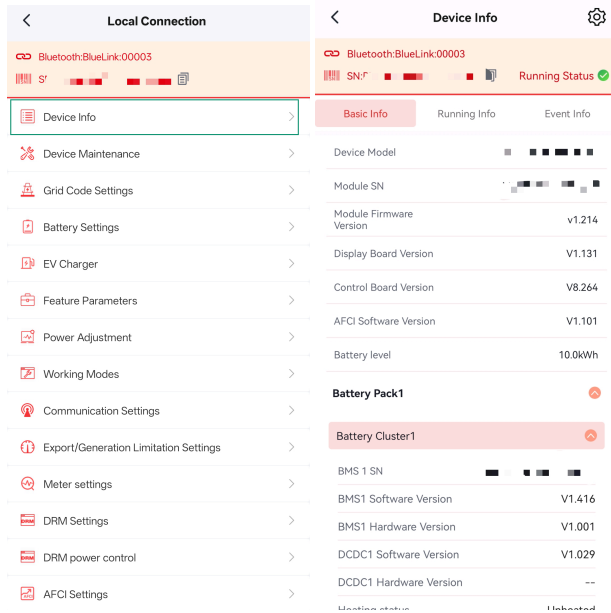

## 8.8. Configure the communication module

1. On the **Device List** page, select the communication module according to the inverter's SN or the communication module's SN.
2. Tap the settings icon  on the upper right corner.

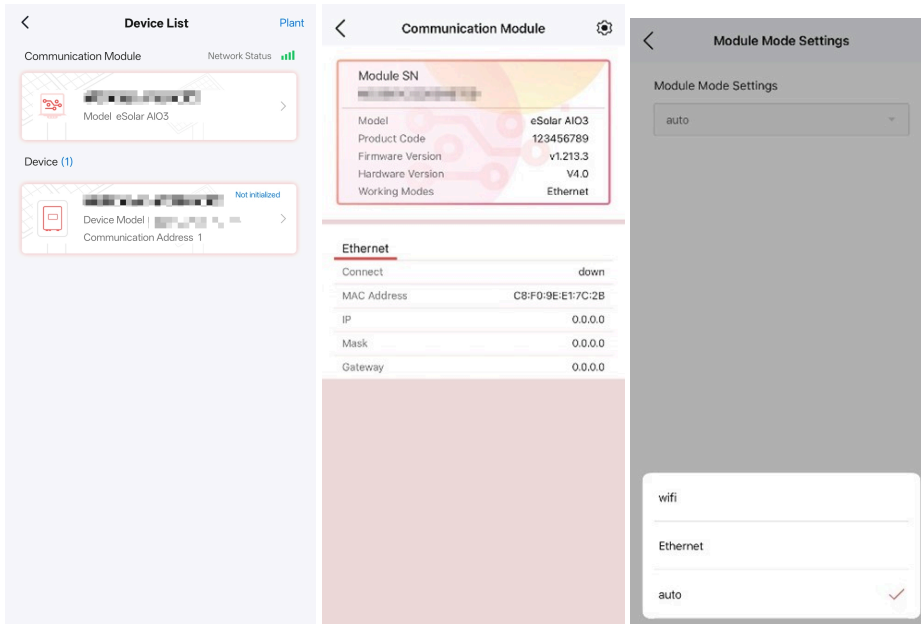

- To change the default network connection mode **auto**, tap **Module Mode Settings** and select the required option.  
**auto**: the communication module uses Wi-Fi or Ethernet connection based on the actual networking condition.
- When **auto** or **wifi** is selected, tap **WiFi configuration**, and input the name and password of the owner’s home network.

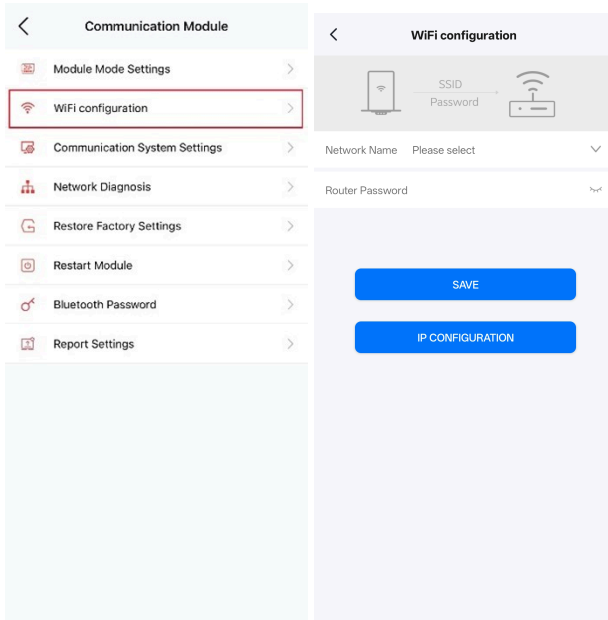

**What to do next**

Check that the network status is up and running.

**8.9. Configure the DRM settings**

When the **Country** is set to **Australia** in the initialization process, set the demand response mode (DRM) according to local regulations as needed.

On the **Local Connection** page, tap **DRM Settings**. Set the required parameters as needed.

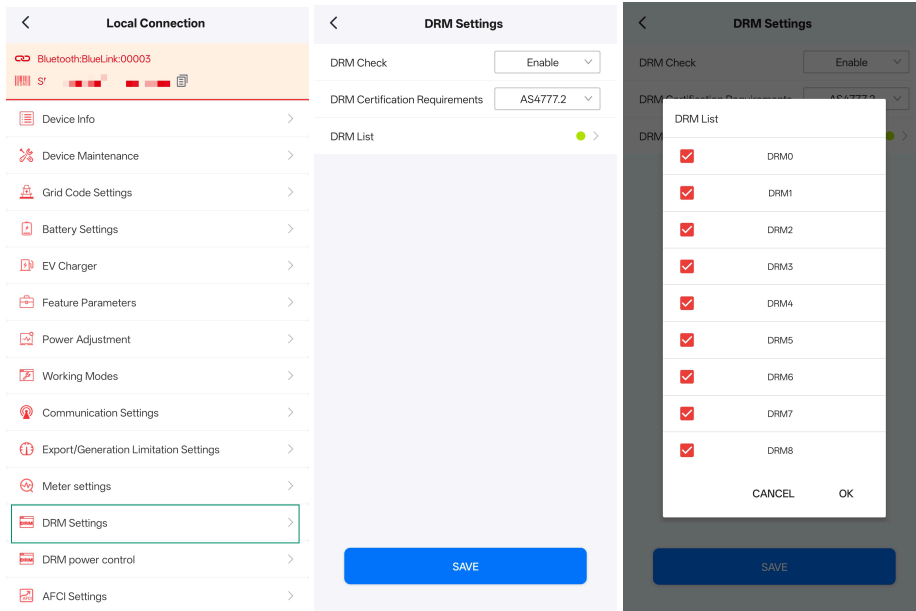

### 8.10. Configure the AFCI function

To enable or disable the AFCI function, on the **Local Connection** page, tap **AFCI Settings**, and choose to enable or disable the anti-arc detection.

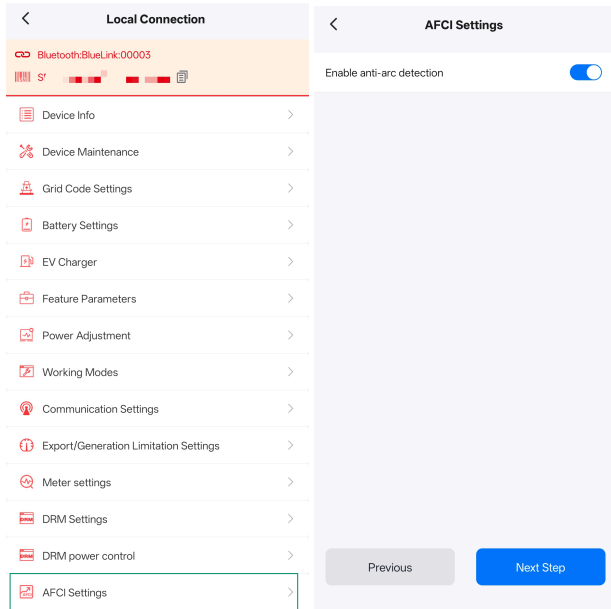

### 8.11. View or configure the V-Watt and Volt-Var modes

This inverter complies with AS/NZS 4777.2: 2020 for power quality response modes. It meets DNSPs' grid connection rules and requirements for the volt-watt and volt-var settings in different regions.

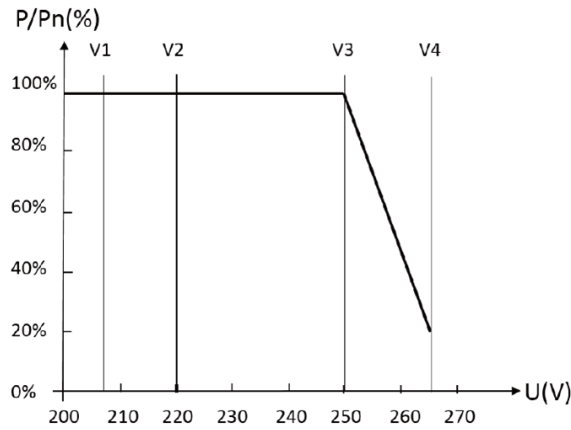

Figure 8.1. Curve for a Volt-Watt response mode (AS4777 Series)

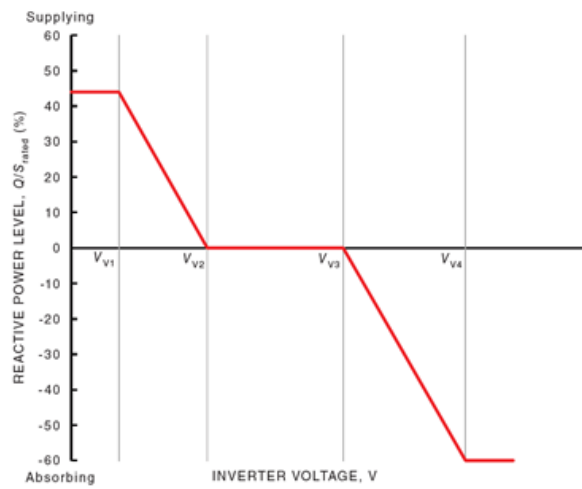

Figure 8.2. Curve for a Volt-Var control mode (AS4777 Series)

**Note:**

With regard to the Power rate limit mode, **SAJ** sets the product WGr<sub>a</sub> to 16.67%P<sub>n</sub> by default in the following cases according to the requirements of 3.3.5.2 as 4777.2: 2020.

- Soft ramp up after connection.
- Reconnect or soft ramp up/down following a response to frequency disturbance.

1. Log in to the elekeeper App and connect to the inverter through Bluetooth connection.
2. On the **Device List** page, tap **Grid Code Settings** and check whether the grid compliance is set to Australia grid codes. Change the settings if needed.

3. On the **Device List** page, tap **V-Watt/V-Var** to enter the settings page.

The screenshot displays the settings interface for a device named 'AS4777\_AustraliaC'. The left sidebar contains the following settings menu items:

- Local Connection (with a power icon)
- Bluetooth Connection: BlueLink:36755
- Safety Settings
- Battery Settings
- Protection Parameters
- Feature Parameters
- Power Adjustment
- Policy configuration
- Communication Settings
- Export/Generation Limitation Settings
- Testing device
- V-Watt/V-Var** (highlighted with a green box)
- Parallel connection setting
- AFCI settings

The main content area is titled 'AS4777\_AustraliaC' and shows the following settings:

- Inverter SN: [blacked out]
- V-Watt** (highlighted in pink)
  - V1: 207.0V
  - V2: 220.0V
  - V3: 253.0V
  - V4: 260.0V
  - %P1: 100.0%
  - %P2: 100.0%
  - %P3: 100.0%
  - %P4: 20.0%
- V-Var** (highlighted in pink)
  - V1: 215.0V
  - V2: 230.0V
  - V3: 240.0V

## 8.12. Create a plant

1. On the **Management** page, tap the ⊕ icon on the top right corner. Select **Create Plant for Owner**.

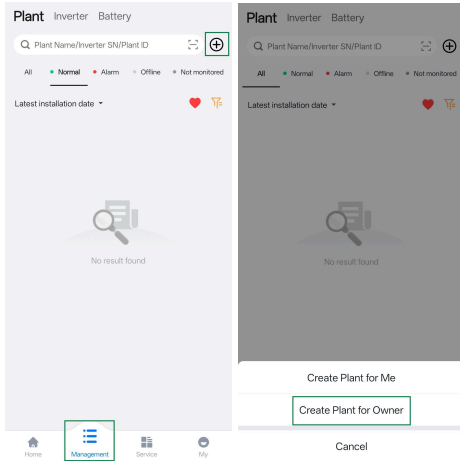

2. Apply for an account for the owner.
  - a. Tap **Register the owner's account**.
  - b. Input the username, country or region, time zone, E-mail, password. Tap **Register**.

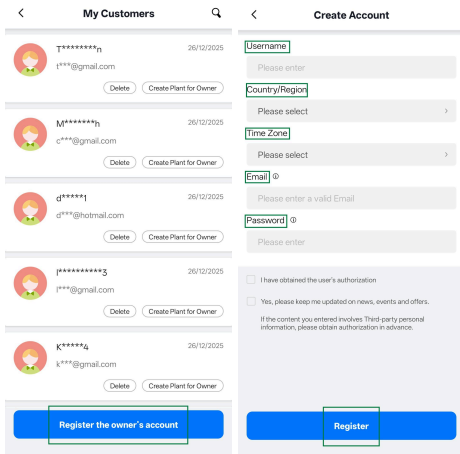

3. Configure the plant details based on the owner's actual conditions.
  - a. Add the required devices for this plant: Scan the SN of each device and tap **Next**.  
The devices include inverters, batteries, and so on.

- b. Configure the plant owner details.
- c. Verify the plant information, tap **Create Plant**.

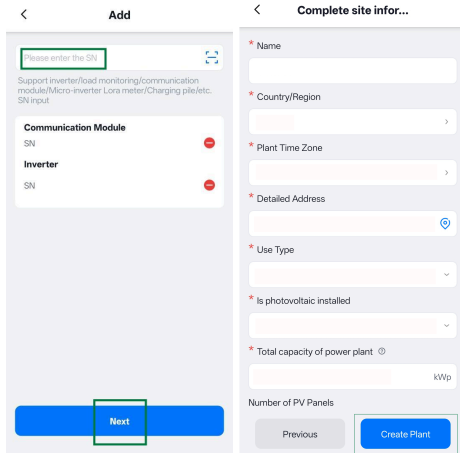

### 8.13. View the plant details

1. On the home page, tap **Plant**.
2. Search for the required plant and then select the plant.
3. On the main page of the plant, view the following plant information:
  - Data update time: In this example, the data has been updated three minutes ago.
  - Working mode
  - **Energy Statistics, Consumption Statistics, and Environmental Benefits.**

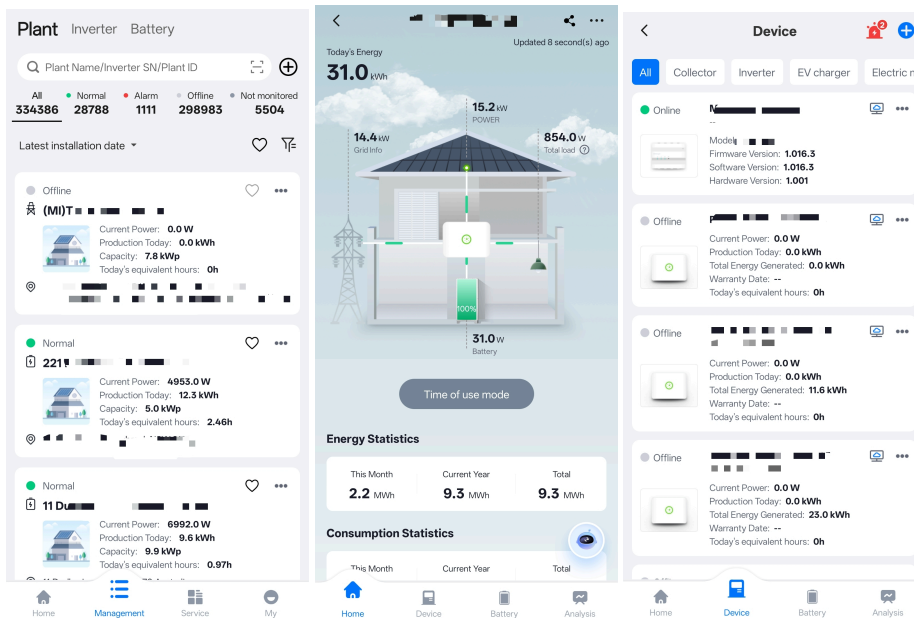

4. To view the detailed information of the devices in this plant, tap the device icon on the image.

## 9. System maintenance

### 9.1. Routine maintenance

To ensure that the system lifespan, perform the suggested routine maintenance operations.



#### Danger of electric shock

Before operating on the system for cleaning, cable inspection, component maintaining, power off the whole system. Do not open any product cover until 5 minutes after disconnecting all sources of supply.

#### Note:

To purchase the routine maintenance service, contact the installer, distributor, or **SAJ** product support.

#### System routine maintenance

Check item	Check method	Maintenance interval
<b>System cleanliness</b>	Check periodically whether the heat sinks are blocked or dirty.	Once every 6 to 12 months
<b>Cleanness of air intake and exhaust vents</b>	Check periodically whether there is dust or foreign objects at the air intake and exhaust vents: <ol style="list-style-type: none"> <li>1. Power off the whole system.</li> <li>2. Remove dust and foreign objects.</li> <li>3. If necessary, remove the baffle plates from the air intake and exhaust vents for cleaning.</li> </ol>	Once every 6 to 12 months (or once every 3 to 6 months based on the actual dust conditions in the environment)
<b>Fan</b>	Check whether the fan generates abnormal noise during operation. Check for and remove any foreign objects from the fan. If the abnormal noise persists, replace the fan.	Once every 6 to 12 months
<b>System running status</b>	<ol style="list-style-type: none"> <li>1. Check whether the inverter is damaged or deformed.</li> <li>2. Check whether the inverter generates abnormal sound during operation.</li> <li>3. Check whether all inverter parameters are correctly set during operation.</li> </ol>	Once every 6 months
<b>Electrical connection</b>	<ol style="list-style-type: none"> <li>1. Check whether cables are disconnected or loose.</li> <li>2. Check whether cables are damaged, especially whether the cable sheath that contacts a metal surface is damaged.</li> </ol>	6 months after the first commissioning and once every 6 to 12 months after that
<b>Grounding reliability</b>	Check whether the PE cable is securely connected.	6 months after the first commissioning and once every 6 to 12 months after that
<b>Sealing</b>	Check whether all terminals and ports are properly sealed.	Once a year

## Battery-specific routine maintenance

Check item	Check method	Maintenance interval
<b>Battery routine maintenance (tool requirement)</b>	<ol style="list-style-type: none"> <li>1. Use only manufacturer-provided professional tools to inspect, test, or service the battery pack.</li> <li>2. Do not disassemble, modify, or perform maintenance on the battery pack without proper training and approved tools.</li> </ol>	Applicable to all battery maintenance activities
<b>Battery module appearance</b>	<ol style="list-style-type: none"> <li>1. Check the battery modules for swelling, deformation, cracks, liquid leakage, corrosion, or abnormal odor.</li> <li>2. Check the battery enclosure for damage, deformation, or signs of overheating.</li> </ol>	Once every 6 to 12 months
<b>Battery terminal and connection check</b>	<ol style="list-style-type: none"> <li>1. Power off the entire system before performing any checks.</li> <li>2. Inspect all battery terminals and connectors for looseness, oxidation, or signs of overheating.</li> <li>3. Verify that all cable connections are tight and properly torqued to the specified value using manufacturer-approved tools.</li> </ol>	6 months after the first commissioning and once every 6 to 12 months after that
<b>Battery operating status &amp; parameters</b>	<ol style="list-style-type: none"> <li>1. Check the battery pack status such as SOC, voltage, current, and temperature.</li> <li>2. Ensure no cell voltage imbalance, over-temperature, or other alarms are reported.</li> <li>3. Verify the battery communicates normally with the inverter/BMS.</li> </ol>	Once every 6 months
<b>Battery ventilation and environment</b>	<ol style="list-style-type: none"> <li>1. Check that the battery compartment and ventilation openings are free of dust, debris, or blockages.</li> <li>2. Ensure the battery is installed in a well-ventilated, cool, and dry environment away from heat sources or direct sunlight.</li> </ol>	Once every 6 to 12 months (or once every 3 to 6 months in dusty environments)

## 9.2. Troubleshooting

For the errors reported as below, contact the service support for further assistance.

The troubleshooting operations must be performed by authorized technicians only.

Error code	Error message
1	Master Relay Error
2	Master EEPROM Error
3	Master Temperature High Error
4	Master Temperature Low Error
5	Master Lost Communication M<->S
6	Master GFCI Device Error

Error code	Error message
7	Master DCI Device Error
8	Master Current Sensor Error
9	Master Phase1 Voltage High
10	Master Phase1 Voltage Low
15	Master Voltage 10Min High
16	Master OffGrid Voltage Low
17	Master Output_Shorter
18	Master Grid Frequency High
19	Master Grid Frequency Low
21	Master Phase1 DCV Error
24	Master No Grid Error
25	DC ReverseConnect Error
26	Parallel machine CAN Com Error
27	Master GFCI Error
28	Master Phase1 DCI Error
31	Master ISO Error
33	Master Bus Voltage High
34	Master Bus Voltage Low
36	Master PV Voltage High Error
37	Master Islanding Error
38	Master HW Bus Voltage High
39	Master HW PV Current High
40	Master SelfTestFailed
41	HW Inv Current High
44	Master Grid NE Voltage Error
45	Master Fan1 Error
49	Lost Communication between DSP and PowerMeter
50	Lost Communication between M<->S
51	Lost Communication between inverter and Grid Meter
52	HMI EEPROM Error
53	HMI RTC Error
55	BMS Lost.Conn Warn
56	CT Device Err
58	Lost Com.H<->S Err
59	Lost Communication between inverter and PV Meter
60	EV_Lost.Conn Warn
78	Grid Power Emergency Disconnect
81	Lost Communication D<->C
83	Master Arc Device Error
84	Master PV Mode Error
85	Authority expires
86	DRM0 Error
87	Master Arc Error

Error code	Error message
88	Master SW PV Current High
89	Master Battery Voltage High
90	Master Battery Current High
91	Master Battery Charge Voltage High
92	Master Battery OverLoad
93	Master Battery SoftConnet TimeOut
94	Master Output OverLoad
95	Master Battery Open Circuit Error
96	Master Battery Discharge Voltage Low
97	BMS Internal Communication Error
98	Bat Sequence Error
99	Discharge Over Current Protect
100	Charge Over Current Protect
101	Module Under Voltage Protect
102	Module Over Voltage Protect
103	Single Cell Under Voltage Protect
104	Single Cell Over Voltage Protect
105	BMS Hardware Error
106	Charge Cell Under Temperature Protect
107	Charge Cell Over Temperature Protect
108	Discharge Cell Under Temperature Protect
109	Discharge Cell Over Temperature Protect
110	Relay Error
111	Pre-charge Error
112	Insulation Error
113	BMS supplier Incompatibility
114	Battery cell supplier Incompatibility
115	Battery cell Incompatibility
116	Battery pack models or grades are inconsistent
117	Circuit Breaker Is Open
118	Temperature Difference Is Too Wide
119	Voltage Difference Is Too Wide
120	Voltage Difference Is Too Wide
121	BMS Over Temperature Protect
122	Short Circuit Protect
123	Total voltage match failed
124	The system is locked
125	FUSE error protection
126	Battery Port Voltage Abnormal Protection
127	Heating Film Overtemperature Protection
128	Abnormal Temperature Increases

## 10. Product specification

### 10.1. EK70 HS5-(5K-10K)-(S3,S4)-X

Model	EK70 HS5-5K-S3- X <sup>1</sup>	EK70 HS5-6K- S3-X	EK70 HS5-6K-S3- X-IE	EK70 HS5-8K- S3-X	EK70 HS5-10K- S4-X	
<b>PV DC Input</b>						
Recommended max. PV power (W)	10000	12000	12000	16000	20000	
Max. Input Voltage (V)	600					
MPPT Voltage Range (V)	50-550					
Operating Voltage Range (V)	50-600					
Start-up Voltage (V)	80					
Nominal DC Input Voltage (V)	360					
Max. Input Current per MPPT (A)	20					
Max. Short-circuit Current per MPPT (A)	25					
Backfeed Current [A]	0					
Number of MPP Trackers	3	3	3	3	4	
No. of Strings per MPP Tracker	3	3	3	3	4	
<b>Battery DC Input</b>						
Battery Type	LiFePO4					
Battery Voltage Range [V]	350-600					
BAT Communication Interface	CAN					
Max. Battery Quantity per System	6					
I <sub>cw</sub> [kA]	≤10 kA (<10s)					
I <sub>cc</sub> [kA]	≤10 kA (<10s)					
<b>AC Output/Input (On-Grid)</b>						
<b>AC Output (On-Grid)</b>	Rated Output Power (W)	4999	6000	5750	8000	9999
	Rated Apparent Power (VA)	4999	6000	5750	8000	9999
	Max. Apparent Power (VA)	4999	6600	5750	8800	9999
	Rated Output Voltage (V)	L+N+PE, 230				
	Rated Output Current (A)	21.7	26.1	25	34.8	43.5
	Max. Output Current (A)	21.7	28.7	25	38.3	43.5
	Current Inrush [A]	105				
	Max. AC Fault Current [A]	120				
	Adjustable Power Factor	0.8 leading-0.8 lagging				
<b>AC Input (On-Grid)</b>	Rated Input Voltage (V)	L+N+PE, 230				

Model	EK70 HS5-5K-S3- X <sup>1</sup>	EK70 HS5-6K- S3-X	EK70 HS5-6K-S3- X-IE	EK70 HS5-8K- S3-X	EK70 HS5-10K- S4-X
Max. Input Current (A)	63 <sup>2</sup>				
Max. AC Over Current Protection [A]	63				
Rated AC Grid Frequency (Hz)	50/60				
Total Current Harmonic Distortion	< 3%				
<b>AC Output (Backup)</b>					
Max. Output Apparent Power (VA)	5000	6000	6000	8000	10000
Peak Output Apparent Power (VA 10s)	10000	12000	12000	16000	20000
Rated Output Voltage (V)	L+N+PE, 230				
Max. Output Current (A)	21.7	26.1	26.1	34.8	43.5
Rated AC Grid Frequency (Hz)	50/60				
Backfeed Current [A]	0				
Adjustable Power Factor	0.8 leading-0.8 lagging				
Total Current Harmonic Distortion	< 3%				
Switch Time (ms)	≤10				
<b>Efficiency</b>					
Euro Efficiency	97.6%				
Max. Efficiency	98.0%				
<b>Protection</b>					
Insulation Monitoring	Integrated				
Residual Current Monitoring	Integrated				
DC Reverse Polarity Protection	Integrated				
Anti-islanding Protection	AFD				
AC Short-circuit Protection	Integrated				
AC Overcurrent/Overvoltage Protection	Integrated				
DC Switch	Integrated				
DC Surge Protection	Type II				
AC Surge Protection	Type II				
AFCI	Integrated				
Inverter Topology	Non-isolation				
Protective Class	I				
AC Overvoltage Category	III				
DC Overvoltage Category	II				
<b>General Data</b>					
Dimensions (W / H / D) (mm)	835 / 690 - 2050 / 270 • Inverter: 835 / 350 / 270 • Battery pack: 835 / 270 / 270 • Battery base: 835 / 70 - 80 / 270				

Model	EK70 HS5-5K-S3- X <sup>1</sup>	EK70 HS5-6K- S3-X	EK70 HS5-6K-S3- X-IE	EK70 HS5-8K- S3-X	EK70 HS5-10K- S4-X
Weight (kg)	<ul style="list-style-type: none"> <li>• Inverter: 39.5</li> <li>• Battery pack: <ul style="list-style-type: none"> <li>- EK70 BU5-6.0-TV: 60.4</li> <li>- EK70 BU5-7.0-TV: 68</li> <li>- EK70 BU5-9.0-TV: 79.2</li> </ul> </li> <li>• Battery base: 8</li> </ul>				
Charging Temperature Range	0°C to +50°C				
Discharging Temperature Range	-10°C to +50°C				
Relative humidity range	5%-95% Non-condensing				
Corrosion resistance grade	C4				
Max. Operating Altitude (m)	3000				
Cooling	Smart air cooling				
Ingress Protection Rating	IP66				
Communication	WLAN / Fast Ethernet / RS485				
Communication Module	eSolar AIO3 Pro / eSolar 4G Pro				
Warranty	Refer to the warranty policy				

1. X stands for the battery system configuration. The value of x can be 6, 7, 9, 12, 14, 15, 16, 18, 21, 24, 25, 27, 28, 30, 35, 36, 40, 42, 45, 50, and 54. Each number presents the energy storage capacity for different models. For battery combinations and ratings, refer to the battery combination datasheet.

2. The built-in 63A bypass function enables the whole-house backup power, and the current can be configured on the elekeeper App.

## 10.2. EK70 battery and battery system designations

The following table lists the battery and battery system designations by SAJ battery code.

The SAJ battery code indicates the manufacturer of the battery cell, which is determined by the sixth character of the serial number (SN) code. The SN is located on the power label attached to the battery. For example, in SN code B5UB4M0Y2552E00002, the sixth character **M** indicates the manufacturer.

SAJ battery code	Battery designation	Battery system designation
M	IFpP74/176/209/[(1P6S)]M/-10+50/95 IFpP74/176/209/[(1P7S)]M/-10+50/95 IFpP74/176/209/[(1P9S)]M/-10+50/95	IFpP74/176/209/[(1P6S)YP]M/-10+50/95(Y=1,2,3,4,5,6) IFpP74/176/209/[(1P7S)YP]M/-10+50/95(Y=1,2,3,4,5,6) IFpP74/176/209/[(1P9S)YP]M/-10+50/95(Y=1,2,3,4,5,6)
N	IFpP73/175/208/[(1P6S)]M/-10+50/95 IFpP73/175/208/[(1P7S)]M/-10+50/95 IFpP73/175/208/[(1P9S)]M/-10+50/95	IFpP73/175/208/[(1P6S)YP]M/-10+50/95(Y=1,2,3,4,5,6) IFpP73/175/208/[(1P7S)YP]M/-10+50/95(Y=1,2,3,4,5,6) IFpP73/175/208/[(1P9S)YP]M/-10+50/95(Y=1,2,3,4,5,6)
O	IFpP73/176/208/[(1P6S)]M/-10+50/95 IFpP73/176/208/[(1P7S)]M/-10+50/95 IFpP73/176/208/[(1P9S)]M/-10+50/95	IFpP73/176/208/[(1P6S)YP]M/-10+50/95(Y=1,2,3,4,5,6) IFpP73/176/208/[(1P7S)YP]M/-10+50/95(Y=1,2,3,4,5,6) IFpP73/176/208/[(1P9S)YP]M/-10+50/95(Y=1,2,3,4,5,6)
I	IFpP74/176/209/[(1P6S)]M/-10+50/95 IFpP74/176/209/[(1P7S)]M/-10+50/95 IFpP74/176/209/[(1P9S)]M/-10+50/95	IFpP74/176/209/[(1P6S)YP]M/-10+50/95(Y=1,2,3,4,5,6) IFpP74/176/209/[(1P7S)YP]M/-10+50/95(Y=1,2,3,4,5,6) IFpP74/176/209/[(1P9S)YP]M/-10+50/95(Y=1,2,3,4,5,6)

SAJ battery code	Battery designation	Battery system designation
K	IFpP74/176/209/[(1P6S)]M/-10+50/95 IFpP74/176/209/[(1P7S)]M/-10+50/95 IFpP74/176/209/[(1P9S)]M/-10+50/95	IFpP74/176/209/[(1P6S)YP]M/-10+50/95(Y=1,2,3,4,5,6) IFpP74/176/209/[(1P7S)YP]M/-10+50/95(Y=1,2,3,4,5,6) IFpP74/176/209/[(1P9S)YP]M/-10+50/95(Y=1,2,3,4,5,6)
J	IFpP73/175/209/[(1P6S)]M/-10+50/95 IFpP73/175/209/[(1P7S)]M/-10+50/95 IFpP73/175/209/[(1P9S)]M/-10+50/95	IFpP73/175/209/[(1P6S)YP]M/-10+50/95(Y=1,2,3,4,5,6) IFpP73/175/209/[(1P7S)YP]M/-10+50/95(Y=1,2,3,4,5,6) IFpP73/175/209/[(1P9S)YP]M/-10+50/95(Y=1,2,3,4,5,6)

### 10.3. Battery

Model	EK70 BU5-6.0-TV	EK70 BU5-7.0-TV	EK70 BU5-9.0-TV
<b>Performance Specification</b>			
Battery Type	LiFePO4		
Cell Capacity (Ah)	314		
Cycle Life <sup>1</sup>	10000		
Total Energy Capacity (kWh)	6	7	9
Usable Energy Capacity (kWh) <sup>2</sup>	6	7	9
Depth of Discharge	100%		
Max. Charging / Discharging Power (W)	3000	3500	4600
Rated Voltage (V)	390		
Max. Charging / Discharging Current (A)	7.7	9.0	11.8
Recommended Charging Method	Charge at constant current of 7.7 A until reaching the maximum voltage of 390 V.	Charge at constant current of 9.0 A until reaching the maximum voltage of 390 V.	Charge at constant current of 11.8 A until reaching the maximum voltage of 390 V.
<b>General Data</b>			
Weight (kg)	60.4	68	79.2
Dimensions (W / H / D) (mm)	835 / 270 / 270		
Storage Temperature Range	-10 °C to +40°C		
Charging Temperature Range	EK70: 0°C to +50°C		
Discharging Temperature Range	EK70: -10°C to +50°C		
Relative Humidity Range	5%-95%		
Max. Operating Altitude (m)	3000		
Cooling Methods	Natural convection		
Ingress Protection Rating	IP66		
Installation Method	Ground mounting / Wall mounting		
Number of Modules per Controller (PCS)	1-6		
Compatible Inverters	EK70 series		

<sup>1</sup> Provided by the battery manufacturer. Test conditions: 25±2°C, 0.5C charge and discharge rate, SOH 60%.

<sup>2</sup> Provided by the battery manufacturer. Test conditions: 100% depth of discharge, 0.2C charge and discharge rate at 25°C, at the beginning of life.



**SJ** | 守护者

**GUANGZHOU SANJING ELECTRIC CO., LTD**

**Tel:** (86) 20 66608588 **Fax:** (86) 20 66608589 **Web:** [www.saj-electric.com](http://www.saj-electric.com)

**Add:** No.9, Lizhishan Road, Science City, Guangzhou High-tech Zone, Guangdong, P.R.China

©2025-2026 Guangzhou Sanjing Electric Co., Ltd. All rights reserved.